



DALI-BOX Interface v2

KNX-DALI Interface for 64 devices / 64 groups

ZDIDLIV2

Application Program Version: [1.2]

Manual Edition: [1.2]_a

www.zennio.com

CONTENTS

Document updates.....	4
1 Introduction	5
1.1 DALI-BOX Interface v2	5
1.2 Installation.....	7
1.3 Compatible Ballasts	9
2 Configuration.....	11
2.1 General Configuration	13
2.1.1 Error Objects.....	19
2.2 Enabling Ballasts.....	25
2.3 Enabling Groups	27
2.4 Scenes.....	28
2.4.1 Configuration	28
2.4.2 Scene N	29
2.5 Sequences	31
2.5.1 Configuration	31
2.5.2 Sequence N	32
2.6 Standby Mode	35
2.7 No Group	39
2.7.1 ECG n.....	39
2.8 Group N	44
2.8.1 Configuration	44
2.8.2 Limits.....	47
2.8.3 Switch & Dimming	48
2.8.4 Status Objects	51
2.8.5 Custom On/Off.....	53
2.8.6 Day/Night Mode	54
2.8.7 Timers	55
2.8.8 Lock.....	58
2.8.9 Alarm.....	59
2.8.10 Custom Initialisation	61

2.8.11	Modes	62
2.8.12	Colour control	65
2.8.13	ECG M	69
3	Display	71
3.1	Main Menu	71
3.2	Installation.....	72
3.2.1	Selection and ECG Testing	72
3.2.2	Group Assignment	73
3.2.3	Address Assignment	73
3.2.4	Ballast Errors.....	74
3.2.5	Operating Time	75
3.3	ECG Detection	76
3.4	Switch All ECGs	76
3.5	Reset All ECGs.....	76
3.6	Manual Control	77
3.7	Scene Control	78
3.8	Burn-in Control.....	78
3.9	Application Version	79
Annex I.	Communication Objects.....	80

DOCUMENT UPDATES

Version	Changes	Page(s)
[1.2]_a	Changes in the manual:	
	• Single Master DALI-2 characteristic	5
	• Reference to DCA manual.	12
	• Device Recovery Objects.	13, 17-18
	• ECG Automatic Detection, Collisions Detection and Standard Bit Timing working.	14-15
	• Group Assignment notes.	25
	• Stand-by explanation.	35-38
• Internal optimization.	-	

1 INTRODUCTION

1.1 DALI-BOX Interface v2

DALI-BOX Interface v2 from Zennio is a KNX-DALI gateway (Single Master DALI-2 controller) that allows controlling, dimming and monitoring up to 64 ballasts in up to 64 groups (16 DALI groups and 48 single groups) in a DALI bus by means of KNX communication objects, which makes it possible to integrate the DALI installation into the building automation system.

Their main functions are:

- **General ballast control** through universal DALI commands.
- Support for **up to 64 DALI ballasts** in total,
- **110V** or **230V** power supply.
- Ballast control **by groups** (16 DALI groups and 48 single groups).
- **Ballast swap** with automatic address re-assignment.
- Light regulation with **customisable dimming** limits and times.
- Selection between logarithmic and linear **regulation curve**.
- Support for colour ballasts (DT8 type) compatible with RGB, RBW and colour temperature functionality.
- Support for the Converter modules.
- **Lock** function.
- **Timed actions**: simple timers, flashing sequences and automatic switch-off.
- **Scenes and sequences**.
- **Custom On/Off** controls.
- **Standby Mode** to help save power consumption in the ballasts by controlling the power supply to the output groups.

- **Error detection and notification.**
- Support for the **Burn-in** mode, required by certain lamps during the switch-on in order to ensure an optimal life period.
- **Test mode and manual configuration of the DALI installation** through the on-board display and pushbuttons.
- **Heartbeat** or periodical “still-alive” notification.

1.2 INSTALLATION

DALI-BOX Interface v2 connects to the KNX bus through the on-board KNX connector. Once the device is provided with power from the KNX bus, both the individual address and the associated application program can be downloaded.

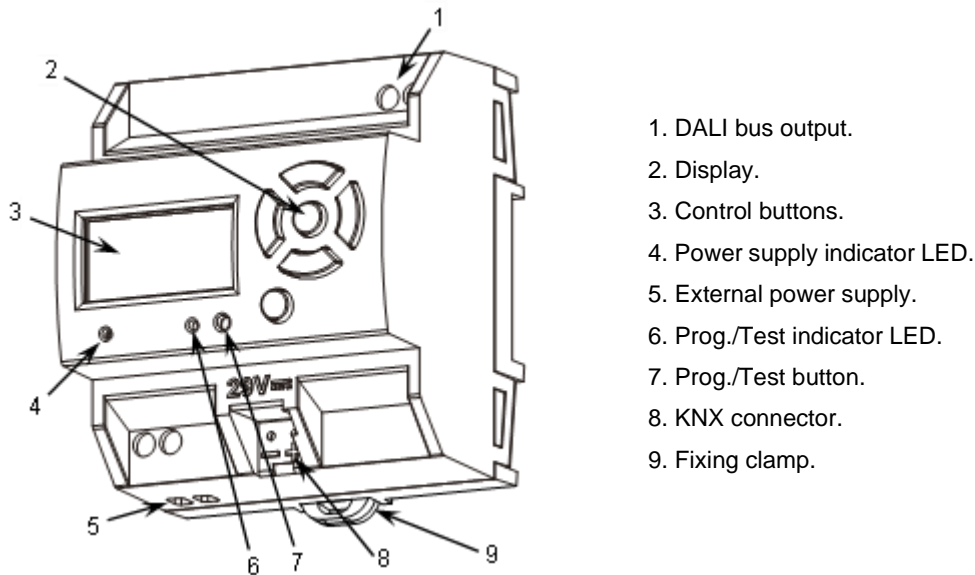

Figure 1. Element Diagram.

The main elements of the device are described next:

- **Prog./Test button (7):** a short press on this button sets the device into the programming mode, making the associated LED (6) light in red.

Note: if this button is held while plugging the device into the KNX bus, the device will enter into **safe mode**. In such case, the LED will blink in red every 0.5 seconds.

- **DALI bus output (1):** slot for the connection of the DALI bus wires.
- **Neutral and Phase Inputs (5):** slots for the connection of the neutral and the phase of the power line.
- **Display (2):** 128x64-pixel screen that provides information about the device and the DALI system and allows the execution of different actions.
- **Control buttons (3):** directional arrows (←↑→↓), confirmation button (**OK**) and exit button (**ESC**) that allow browsing through the options on the display.

To get detailed information about the technical features of the device, as well as on the installation and security procedures, please refer to the corresponding **Datasheet**, bundled with the original package of the device and also available at www.zennio.com.

1.3 COMPATIBLE BALLASTS

DALI-BOX Interface v2 is able to control DALI-certified ballasts (i.e., with the DALI logo). Specifically, it is designed to be compatible with types 0, 1, 2, 3, 4, 5, 6, 7 and 8 of the DALI device type classification, shown in Table 1. Please note that future versions of the application program may support additional ballast types.

Device type	Particular requirements for control gear	Defined in
0	Fluorescent lamps	IEC 62386-201
1	Self-contained emergency lighting	IEC 62386-202
2	Discharge lamps (excluding fluorescent lamps)	IEC 62386-203
3	Low voltage halogen lamps	IEC 62386-204
4	Supply Voltage controller for incandescent lamps	IEC 62386-205
5	Conversion from digital into D.C. voltage	IEC 62386-206
6	LED modules	IEC 62386-207
7	Switching function	IEC 62386-208
8	Colour control	IEC 62386-209
9	Sequencer	IEC 62386-210
10	Optical control	IEC 62386-211
11 to 127	Not yet defined	
128 to 254	Reserved for control devices	
255	Control gear supports more than one device type	

Table 1. DALI device type classification.

Proper operation cannot be guaranteed for other ballasts.

Nevertheless, not all DALI-certified ballasts behave the same way – certain particularities apply:

- Ballasts with LED loads do not report lamp failures; therefore, with these ballasts it is not possible to notify such circumstance to the KNX bus.
- When a lamp failure takes place, certain ballasts with fluorescent lamps may cause the remaining lamps flash briefly.
- Fluorescent-lamp ballasts need an extra time to switch off the load when a non-immediate regulation to 0% is commanded.
- Certain ballast models, on the event of a DALI communication error (e.g., short-circuit or power failure), do not switch to the dimming value configured for such

circumstance – the ballast will maintain the last dimming value that may have been set.

- Some lamps may implement a significant delay when they are switched on. Such circumstance must be considered in case of parameterising timed actions or flashing and dimming sequences.
- The ability to report ballast errors will depend on the ballast itself. The documentation provided by the manufacturer should indicate whether such functionality is available or not.

There may be some other (minor) particularities depending on the ballasts and on the lamps in the installation. Therefore, the integrator is advised to perform some testing to ensure compatibility.

Recommendation: *it is advisable to install only one ballast type within the same group in order to avoid ballast control issues.*

2 CONFIGURATION

The **DALI-BOX Interface v2** application program allows controlling up to 64 DALI ballasts divided into up to 64 groups. The groups 1 -16 are defined by the DALI Standard. The groups 17-64 are not defined by DALI Standard, so it is only possible to set a ballast. Such control is performed according to a set of customisable options which make DALI-BOX Interface v2 a very versatile device:

- Different alternatives to **control the luminosity** of the connected loads:
 - One-bit objects to **switch on / switch off** each group,
 - Four-bit objects for per-group **step dimming**,
 - One-byte (percentage) objects for **absolute dimming** (per group).
- **General dimming** features:
 - Configurable **dimming times**, being possible to modify them through communication objects. Up to three different dimming times are available.
 - **Configurable regulation type**. Logarithmic and linear regulation are available.
 - Dimming limits, i.e., **maximum and minimum lighting** levels.
 - Minimum luminosity level reachable by each group, i.e., the **ballast physical minimum**.
 - Maximum luminosity level allowed in the ballasts under the **economy mode**.
 - **Standby**: mode that allows an external actuator to interrupt the power supply to the ballasts after switching off the loads, thus reducing the power consumption.
- **Custom on/off**: possibility of enabling and configuring different switch-on/off controls for each group, with custom dimming values and times.
- **Simple timer and flashing**: sequence of timed switch-on and switch-off of the ballasts connected to the device.

- **Scenes:** up to 64 different customisable scenes, which can be simultaneously associated to different groups.
- **Sequences:** up to 16 different sequences, which can be associated to different groups. Up to five step actions per sequence can be defined, as well as the dimming type of each step action among other things.
- **Lock:** group control enabling/disabling, with the additional option to define actions for the lock and unlock events.
- **Initialisation:** custom configuration of the initial status (upon the recovery of the KNX bus power or after an ETS download or a restart) for each group, or either of an initial sending (immediate or delayed) of the status to the bus.
- **Error identification:** detection of anomalies that may affect the proper operation of the device: power supply error, short circuit, ballast presence error or ballast and group diagnostic errors.
- **Special operation modes:**
 - **Auto Off:** mode that allows automatically switching off a group in case it remains steady under a certain parameterisable dimming threshold for more than a defined time period.
 - **Burn-in:** mode that prevents the execution of dimming orders during a certain, parameterisable time period after the switch-on of the ballast, with the aim of stabilising the lamp response and of optimising its life time. Certain lamp models may require this feature.
- **ECG Automatic Detection:** possibility of enabling the ECG Automatic Detection.
- **Collisions Detections:** possibility of enabling the Collisions Detections.

Other than these functions, the general settings of the device allow enabling each of the **64 ballasts (or ECGs)** supported as maximum and assigning it, if desired, any of the **64 groups** available.

Moreover, the ECGs commissioning can be performed by means of a DCA. A specific manual can be referred at www.zennio.com.

2.1 GENERAL CONFIGURATION

The general configuration of DALI-BOX Interface v2 basically consists in defining the **dimming times**. They are the length of the transition from switched off (0%) to the maximum luminosity level (100%), which determines the speed of the regulation. **Up to three different dimming times** can be applied to the different orders or actions, and their values may be changed through three communication objects (one per each dimming time).

Note: *Due to DALI limitations, every colour dimming has a settled time of 2 seconds from start value to finish value (except the sequences, see section 2.5).*

In case of configuring **dimming limits** (see section 2.8.2), the dimming times will be applied as follows:

- Transitions between 0% and the minimum dimming value will be instantaneous.
- Transitions between the minimum dimming value and the maximum dimming value will take the proportional part of the parameterised dimming time (which must be understood as the time corresponding to the entire transition from 0% to 100%).

Moreover, the general configuration allows enabling the following functions:

- **Scenes.** See section 2.4.
- **Sequences.** See section 2.5.
- **Standby.** See section 2.6.
- **Dimming Value During KNX Bus Failure:** sets the dimming level that will be adopted by the ballasts if KNX Bus Failure takes place.
- **Error Objects.** See section 2.1.1.
- **Heartbeat** or periodical “still-alive” notification.
- **Device Recovery Objects:** after starting the application program, two 1-bit communication objects are sent to the KNX bus.

- **ECG Automatic Detection after download:** DALI-BOX Interface v2 is able to detect new ballast which are just connected to the DALI line, whether or not they have an individual address associated, as well as carrying out monitoring of those ballasts with an individual address detected.

If ECG Automatic Detection is not enabled, DALI-BOX Interface v2 will only be able to monitor ballast whose individual address have been detected before for the device.

This functionality can be enabled or disabled by communication object, by using the display submenu or using the DCA DALIBOX Tool and it can be chosen by parameter if after downloading it will be enabled by default.

Notes:

- *For correct installation, it is recommended to enable ECG Automatic Detection for at least five minutes before deactivating it and starting manual redirection.*
- *If there is no proper ECG detection, it is possible to control ballasts, but there might be failures in the error detection, the status of the ballast will not be reflected on the KNX bus and actions derived from its status will not work.*

- **Maintain Previous ECG Detection after Download:** DALI-BOX Interface v2 is able to save the configuration and detection of the ballasts after a download, avoiding having to make a new automatic detection of all of them.

If this parameter is disabled, DALI-BOX Interface v2 will not show any ballast until the automatic detection is done.

- **Collisions Detections after download:** DALI-BOX Interface v2 is able to analyse the responses of the ballasts to detect those that have been assigned the same individual address.

This functionality can be enabled or disabled by communication object or by using the display submenu and it can be chosen by parameter if after downloading it will be enabled by default.

Important: *when Collisions Detection is not enabled, some features as error detection, ballast configuration, or emergency tests could not work properly.*

Notes:

- *In case the collision detection is disabled and there are several ballasts in the installation with the same assigned address, all of them will respond in the same way to the control commands.*
- *To ensure correct operation, it is recommended to enable Collision Detection when ECG Automatic Detection is active. Once the installation is complete, it is recommended to deactivate both.*

- **Standard Bit Timing:** this function allows customising the time threshold after which the arrival of a new bit through the DALI bus will be considered as corrupt, for instance to prevent telegram collisions in case several ballasts have been assigned the same address. Preserving the standard threshold is highly encouraged, unless intending to connect very specific ballasts that may require modifying it.

Notes:

- *It is recommended to increase the Standard Bit Timing in cases where some ballasts are not detected or there are problems with random address changes.*
- *When the Standard Bit Timing time is at maximum and there are still problems with address changes, it is recommended to disable Collisions Detection.*

- **Manual Control Lock:** provides an optional procedure for locking the manual control in runtime.

ETS PARAMETERISATION

After importing the corresponding ETS database and adding the device to the project topology, the configuration process begins by entering the Parameters tab of the device.

The tab tree on the left shows the “General” tab in the first place. This entry itself comprises the following parameters:

Figure 2. General

- **Dimming Times:** three dimming times may be parameterised, through the following parameters:
 - **Dimming Time n** [1...5...255] [s/min]¹: sets dimming time n (1-3).
 - **Dimming Time Objects** [enabled/disabled]: enables three general two-byte objects, named “Dimming Time n ”, which allow changing the dimming times parameterised.

¹ The default values of each parameter will be highlighted in blue in this document, as follows: [default/rest of options].

- **Independent Functions:**

- **Scenes** [[enabled/disabled](#)]. See section 2.4.
- **Sequences** [[enabled/disabled](#)]. See section 2.5.
- **Standby** [[enabled/disabled](#)]. See section 2.6.

- **General Functions:**

- **Dimming Value During KNX Failure** [[Off / Defined Value / No Change](#)]: in case of selecting “[Defined Value](#)” the ballast will switch to a customisable value [[0...100](#)] [%].

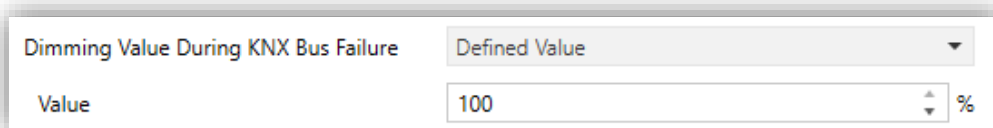

Dimming Value During KNX Bus Failure Defined Value

Value 100 %

Figure 3. Dimming level for KNX Bus Failure

- **Error Objects** [[enabled/disabled](#)]. See section 2.1.1.
- **Heartbeat (Periodical Alive Notification)** [[enabled/disabled](#)]: this parameter lets the integrator incorporate a one-bit object to the project (“**[Heartbeat] Object to Send ‘1’**”) that will be sent periodically with a value of “1” to notify that the device is still working (still *alive*).

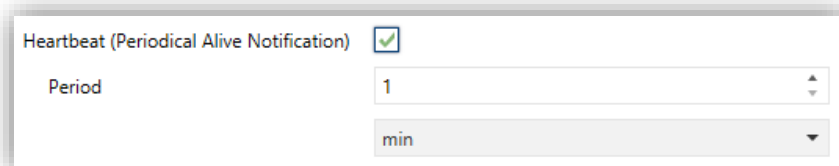

Heartbeat (Periodical Alive Notification)

Period 1

min

Figure 4. Heartbeat.

Note: The first sending after download or bus failure takes place with a delay of up to 255 seconds, to prevent bus overload. The following sendings match the period set.

- **Device Recovery Objects (Send 0 and 1)** [[disabled/enabled](#)]: this parameter lets the integrator activate two new communication objects (“**[Heartbeat] Device Recovery**”), which will be sent to the KNX bus with values “0” and “1” whenever the device begins operation (for example, after

a bus power failure). It is possible to parameterise a certain **delay** [\[0...255\]\[s\]](#) to this sending.

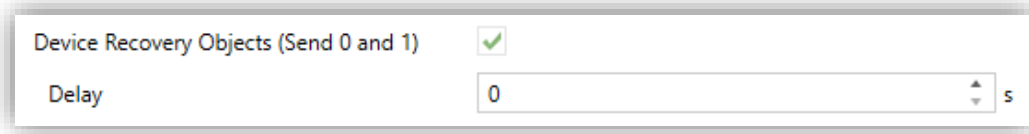

Figure 5. Device Recovery Objects.

Note: After download or bus failure, the sending takes place with a delay of up to 6,35 seconds plus the parameterised delay, to prevent bus overload.

- **ECG Automatic Detection after Download** [\[enabled/disabled\]](#): enables or disables the ECG Automatic Detection after download. Regardless of the value of this parameter, this functionality can be disabled through the object “**ECG Automatic Detection**”, which is always available, or through the display submenu (see section 3.3).
- **Maintain Previous ECG Detection after Download** [\[enabled/disabled\]](#): maintain the detection and configuration of the ballasts between discharges.
- **Collisions Detection after Download** [\[enabled/disabled\]](#): enables or disables the Collisions Detection after download. Regardless of the value of this parameter, this function can be activated or deactivated with the “**Collisions Detection**” object, which is always available.
- **Standard bit timing** [\[enabled/disabled\]](#): allows enabling or disabling the manual configuration of the bit detection time. The standard value set by default is 500 µs.
 - **Maximum time for one-bit phase** [\[500...650\]](#): sets the new threshold value.

Note: preserving the standard threshold is highly encouraged, unless intending to connect very specific ballasts that may require modifying it.

Figure 6. Standard Bit Timing.

- **Manual Control Lock Object** [*enabled/disabled*]: when enabled, 1-bit object “**Manual Control Lock Object**” turns visible, as well as two more parameters:
 - **Object Polarity** [*0 = Unlock; 1 = Lock / 0 = Lock; 1 = Unlock*]: defines whether the manual control lock/unlock should take place respectively upon the reception (through the aforementioned object) of values “0” and “1”, or the opposite.
 - **Initialization** [*Unlock / Locked / Last Value*]: sets how the manual control should remain after the device start-up (after an ETS download or a bus power failure). On the very first start-up, “Last Value” will be Unlocked).

Figure 7. Manual Control Lock Object

2.1.1 ERROR OBJECTS

DALI-BOX Interface v2 is able to **detect certain errors** that may occur during normal operation, which will be indicated through the display (section 3) or reported to the KNX bus (periodically every minute), if configured.

- The **DALI power supply error** is reported when the external power supply is interrupted and therefore the DALI bus becomes non-functional. In such case, the ballasts will adopt the level configured for DALI bus failure cases (see section 2.8.1), as the ballasts have their own power supply. In case this is interrupted too, they will obviously switch off.

During the power supply error, control actions will be ignored. Other error types will not be reported, either. Nevertheless, the lock objects (see section 2.8.8) will be considered so once the error is over the corresponding action can be performed.

- The **short-circuit error** is reported in case the communication is interrupted due to issues on the DALI bus. In such cases, the ballasts will acquire the value configured for DALI bus failure cases (see section 2.8.1).

While this error persists, the following errors will no longer be notified, due to a lack of communication with the ballasts:

- ECG presence error (see below).
 - ECG and group diagnostic (see below).
- The **ECG presence error** is notified when at least one of the already-detected ballasts no longer responds. The detection of this error may not be immediate, being it possible that the device takes up to two minutes to report it. If a regulation order is sent to a ballast whose presence error has not been detected yet, the order will not be executed and one of the following will take place:
 - If the error is solved before having been detected, the ballast will remain under a wrong dimming value until the next regulation order.
 - If the error is finally detected, once it is solved the ballast will be regulated to the last value received from the KNX bus.

Important:

- **To let reducing the number of ballasts in the installation** (which may cause a permanent ballast presence error), the Write flag of the communication object that reports this error has been enabled, so the error can be cleared by sending it the value “0”. Whenever this happens, the device will assume the current number of ballasts as correct. This can also be done via the display, as detailed in section 3.

- **To replace a defective ballast**, please proceed as follows:
 1. Disconnect the defective ballast keeping DALI-BOX Interface on.
 2. Wait for the detection of the ECG presence error (which may take up to 120 seconds).
 3. Clear the ballast presence error (via object or display).
 4. Connect the new ballast (it will be assigned the first DALI address available).
 5. Assign the new ballast the address of the removed ballast.

If, despite following these steps, the new ballast is not detected correctly or is not well configured, disconnect it for at least two minutes and reconnect it. Thus, DALI-BOX Interface will reconfigure it.

Note: *in case an open circuit takes place (either due to the disconnection of the DALI bus or to a general power failure of the ballasts), DALI-BOX Interface v2 will report an ECG presence error for each ballast.*

- The **diagnostic errors** are errors detected by the ballasts themselves. DALI-BOX Interface v2 is informed about them when it requests the status from the ballast.
 - **ECG Failure:** the ballast cannot operate normally. The reasons that cause this error depend on the manufacturer.

 - **Lamp failure:** the lamp cannot be switched on normally, either due to a defect (burned-out bulb) or to an incorrect connection.

Note: the dimming level must be higher than 0% to detect the lamp failure error. Otherwise, even if the lamp is burnt out, the ECG will not be able to detect it.

Note that in case the ballast does not implement this function, DALI-BOX Interface v2 will not be able to report these errors.

Blocking errors (short-circuit and lack of power supply) will interrupt all actions, including timed actions. Other errors will not interrupt them – they will still be executed by all connected ballasts that do not present errors.

ETS PARAMETERISATION

The Error Objects function can be parameterised from the “General” tab. Once enabled through its own checkbox, the following options become available:

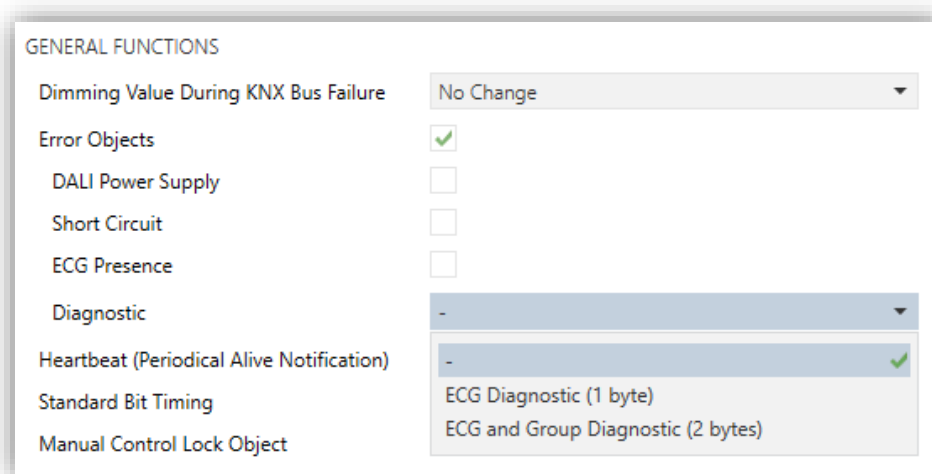

Figure 8. Error Objects

- **DALI Power Supply** [*enabled/disabled*]: enables a one-bit object (“**Error: DALI Power Supply**”) that will notify the existence of a power supply failure in the device by sending a value of “1”. Once the error is over, it will send a value of “0”.
- **Short Circuit Error** [*enabled/disabled*]: enables the “**Error: Short Circuit**” object, which will be sent with a value of “1” in case of detecting communication errors or a short circuit in the DALI bus. After the error is over, it will be sent once with a value of “0”.
- **ECG Presence** [*enabled/disabled*]: enables the “**Error: ECG Presence**” object, which will be sent with a value of “1” in case of detecting a ballast

presence failure. After the error is over, it will be sent once with of “0”. This object will also allow the user to erase all device presence errors, by means of resetting the appropriate addresses.

- **Diagnostic:** enables the diagnostic errors function, which allows DALI-BOX Interface v2 forwarding to the KNX bus any ECG errors and lamp errors it may obtain from the ballasts. The object type for these sendings must be configured:

- ECG Diagnostic (1 byte): object with DPT [238.600].
- ECG and Group Diagnostic (2 bytes): object with DPT [237.600].

Object	DPT	Format											
ECG Diagnostic	[238.600]	<table border="1"> <tr> <td>BF</td> <td>LF</td> <td>Addr</td> </tr> </table> <p>BF: set to “1” in case of ECG failure (“0” in another case). LF: set to “1” in case of lamp failure (“0” in another case). Addr: address of the ballast.</p>	BF	LF	Addr								
BF	LF	Addr											
ECG and Group Diagnostic	[237.600]	<table border="1"> <tr> <td>r</td> <td>r</td> <td>r</td> <td>r</td> <td>r</td> <td>CE</td> <td>BF</td> <td>LF</td> <td>RR</td> <td>AI</td> <td>Addr</td> </tr> </table> <p>BF: set to “1” in case of ECG failure (“0” in another case). LF: set to “1” in case of lamp failure (“0” in another case). RR: set to “1” on requests and to “0” on responses. AI: set to “1” for groups and to “0” for ballasts. Addr: address of the ballast (0-63) or of the group (0-31). r: bits set to “0”.</p>	r	r	r	r	r	CE	BF	LF	RR	AI	Addr
r	r	r	r	r	CE	BF	LF	RR	AI	Addr			

Table 2. DPT specification (238.600 and 237.600).

Regardless of the selected type, the object will be automatically sent as soon as DALI-BOX Interface v2 is notified about the occurrence of any of these errors in any of the ballasts. The error type and ballast address are coded in the object value, according to the specification of the DPTs.

On the other hand:

- The **Read flag** of the one-byte object has been enabled so it can receive read requests any time. The information returned by the object is always referred to the last ballast that presented an error.

- The **Write flag** of the two-byte object has been enabled so it can receive requests specifically for a particular ballast or group.

Although the two-byte object admits requesting information about a specific group, all automatic sendings will always be referred to ballasts.

2.2 ENABLING BALLASTS

Once the general configuration has been defined, it is possible to enable each of the ballasts and assign it, if desired, a specific group according to the number of loads to be controlled and their distribution along the DALI installation. In case this assignment had already been performed, successive downloads will overwrite it or not according to the parameterisation.

DALI-BOX Interface v2 can control up to 64 ballasts, distributed along up to 64 groups. Bear in mind that ballasts can still be configured even if they are not assigned any group (which can be manually done afterwards, by means of the display).

Note that for **groups 17 through 64** only one ballast can be assigned per group, whereas **groups 1 through 16** may contain several ballasts.

ETS PARAMETERISATION

The “Enable ECGs” tab allows enabling each of the ballasts and optionally assigning them a group, according to the following parameters:

GENERAL	ENABLE ECGS
ENABLE ECGS	Overwrite groups assignment when downloading <input type="checkbox"/>
ENABLE GROUPS	After download the groups and ballasts assignment carried out previously will be kept
	Enable ECG 1 <input type="checkbox"/>
	Enable ECG 2 <input type="checkbox"/>
	Enable ECG 3 <input type="checkbox"/>
	Enable ECG 4 <input type="checkbox"/>
	Enable ECG 5 <input type="checkbox"/>
	Enable ECG 6 <input type="checkbox"/>
	Enable ECG 7 <input type="checkbox"/>
	Enable ECG 8 <input type="checkbox"/>
	Enable ECG 9 <input type="checkbox"/>
	Enable ECG 10 <input type="checkbox"/>

Figure 9. Enabling ECGs

- **Overwrite groups assignment when downloading** [*enabled/disabled*]: sets whether the group assignments of the ballasts should be overwritten after downloading the new parameterisation or maintained in case it had already been performed (either through previous parameter downloads or by means of

the on-board controls and display).

In case this option is left **disabled**, the following parameter is shown:

- **Enable ECG N** [*enabled/disabled*]: sets which ballasts will remain enabled. Note that, although they may have been assigned a group previously, they will be shown under the “No group” tab (see section 2.4).

On the other hand, if **enabled**, the following parameter is shown:

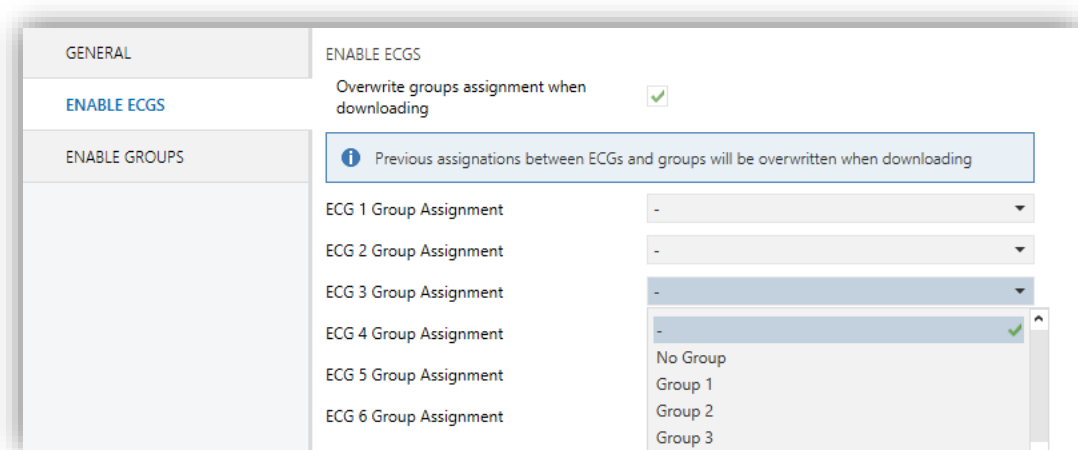

Figure 10. Enabling ECGS

- **ECG N Group Assignment** [*- / No Group / Group Y*]: sets which ballasts will remain enabled and, optionally, the group assigned to each of them:
 - “-”: ballast N is disabled.
 - No Group: ballast N is enabled but has no group assigned.
 - Group Y: ballast N is enabled and associated to group Y.

Note: groups 17 – 64 are one-ballast groups.

Important:

- Any groups being assigned to ballasts must also be explicitly enabled. See section 2.3.
- If a download is executed by changing the groups assignment and the ECG Detection parameter is disabled, it is necessary to force an ECG Detection to configure the ballasts correctly. See section 2.1.

A specific sub-tab will be available per ballast under the tab of the group the ballast belongs to. See section 2.8.13.

2.3 ENABLING GROUPS

Any group containing at least one ballast (or that may contain it after later assignments performed via the display of the device) must be explicitly enabled. Moreover, this makes it possible to configure the desired functions for each group, as described in section 2.8.

ETS PARAMETERISATION

The “Enable Groups” tab allows enabling each of the groups that may be or may have been assigned to the ballasts.

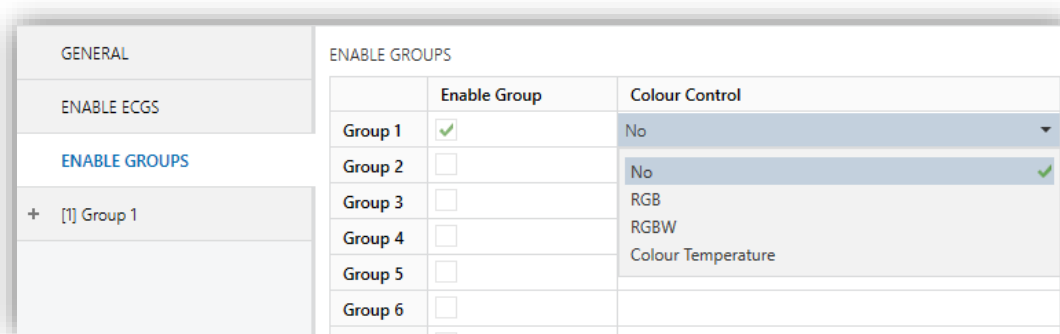

Figure 11. Enabling groups

One checkbox is provided per group:

- **Enable Group** [*disabled/enabled*]. For each enabled group, a new tab named “**Group N**” (N = 1 to 64) will be incorporated into the tab tree on the left. Please refer to section 2.8 for details.

Once the groups are enabled, the following parameter will be displayed:

- **Colour Control** [*No / RGB / RGBW / Colour Temperature*]: Sets whether the ballast group is to be used to control coloured ballasts and the type of ballasts to be controlled. See section 2.8.12 for details.

2.4 SCENES

2.4.1 CONFIGURATION

This feature allows defining different scenes (i.e., specific ambiances or dimming sequences), which can be activated by sending the corresponding trigger values to a **one-byte object**.

DALI-BOX Interface v2 offers **up to 64** configurable scenes which can be assigned to the different enabled groups.

ETS PARAMETERISATION

Once this function has been enabled, the following object will show in ETS:

- **“Scene Control”** (one byte): will execute or save the scene whose number is received through the object.

The “Scenes” tab in ETS, on its side, contains a sub-tab named “Configuration”, which shows the following parameters:

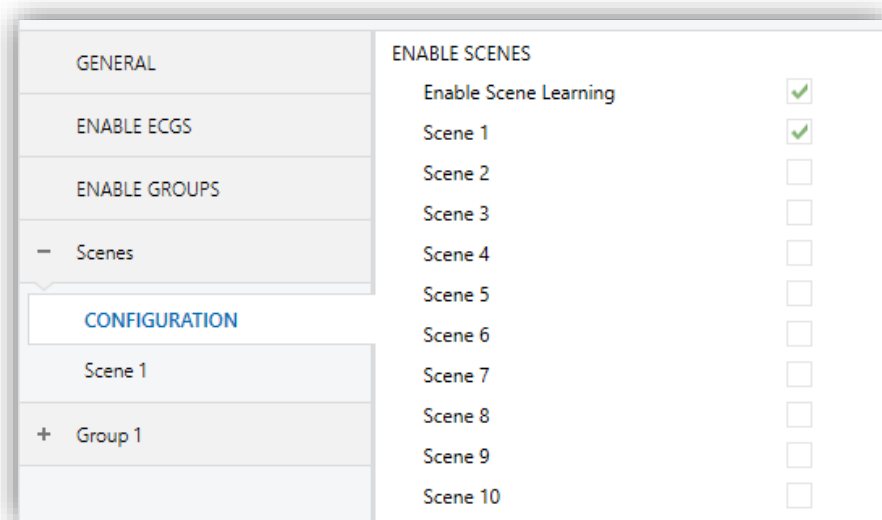

Figure 12. Configuration

- **Enable Scene Learning** [*enabled/disabled*]: enables the possibility of overwriting a certain scene when the appropriate value is received from the bus through the aforementioned object.
- **Scene N** [*enabled/disabled*]: enables scene number N (1 to 64).

Each scene activated from this screen will have a specific tab associated, labelled as “Scene n ”, as detailed next.

2.4.2 SCENE N

Each of up to 64 scenes must be assigned a certain identifier, i.e., their scene number with regards to the KNX system. When this value is received through the scenes object, the scene will be executed (or saved, in case the value is received incremented by 128, according to the KNX standard).

The specific action to be performed by each group on the execution of the scene can be selectively configured.

ETS PARAMETERISATION

	Associate to Scene	Dimming Value/Channels RGB	Channel W/Colour Temperature
Group 1	<input checked="" type="checkbox"/>	100 %	
Group 2	<input checked="" type="checkbox"/>	#FFFFFF	
Group 3	<input checked="" type="checkbox"/>	#FFFFFF	255
Group 4	<input checked="" type="checkbox"/>	100 %	3000 K

Figure 13. Scene N

- **Scene Number** [1..64]: sets the scene identifying number whose reception through the “**Scene Control**” object will make the device execute or save the scene depending on the case.
- **Name**: 12 characters text that allows set the scene name. That name is displaying in the scene tab.
- **Available Groups**: Depending on parametrization of tab “ENABLE GROUPS” (section 2.3), different options can be setting:
 - **Associate to Scene** [*disabled/enabled*]: allows associating the scene to the different available groups and configuring the target dimming level.

Depending on the option assigned to **Colour Control** parameter, on “Enable Groups” tab (section 2.3), different options can be setting:

➤ **Dimming Value / Channels RGB:**

- Colour Control: “No” → **Dimming Value** [0...100][%].
- Colour Control: “RGB” → **Channels RGB** [#000000...#FFFFFF].
- Colour Control: “RGBW” → **Channels RGB** [#000000...#FFFFFF].
- Colour Control: “Colour Temperature” → **Dimming Value** [0...100][%]

➤ **Channel W / Colour Temperature:**

- Colour Control: “RGBW” → **Canal W** [0...255]
- Colour Control: “Colour Temperature” → **Colour Temperature** [1000...3000...20000][K].

Notes:

- *Every dimming will be carried out immediately.*
- *Take in account that there may be different scenes associated with the same group.*

2.5 SEQUENCES

2.5.1 CONFIGURATION

This feature allows defining **up to 16** configurable dimming sequences, which can perform actions on different groups. Sequences can be executed simultaneously, as starting a new one does not stop other sequences in execution.

ETS PARAMETERISATION

Once this function has been enabled, the following objects will show in ETS:

- **“Sequence Control”** (one byte): will trigger the sequence whose number is received through the object, as detailed next:

Sequence Number	Stop	Start
1	0	128
2	1	129
...
64	63	191

Table 3. Sequence Control

- **“Sequence Launcher”** (one byte): similar to the scenes object (see section 2.4), but without the “save” functionality:

Sequence Number	Start
1	0
2	1
...	...
64	63

Table 4. Sequence Launcher

- **“Stop Sequences”** (one bit): interrupts all current sequences when it receives either a “1” or a “0”.

The **“Configuration”** tab in ETS contains the following parameters:

- **Sequence N** [*enabled/disabled*]: enables sequence number N.

A specific tab will be incorporated for each sequence being enabled.

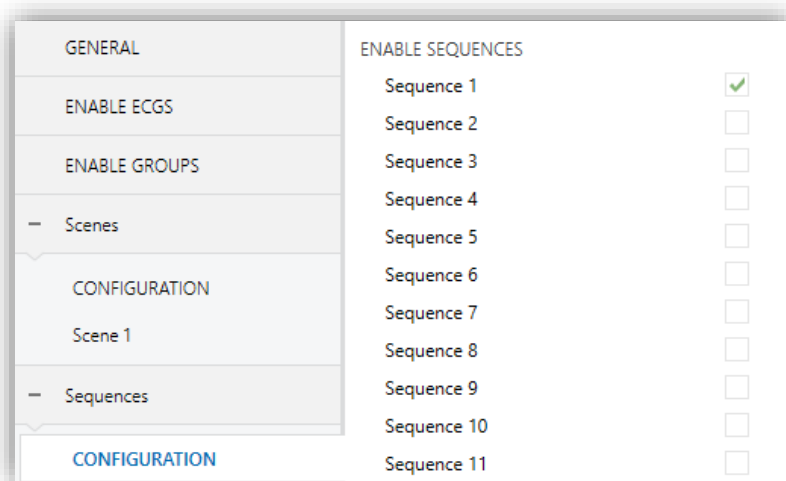

Figure 14. Configuration

2.5.2 SEQUENCE N

Each sequence can consist of up to **five actions** executed sequentially. For each of the actions, it is possible to set the group over which the action will be performed, as well as the target dimming value, the dimming type (at once or smooth) and the total length of the action prior to trigger the next one.

ETS PARAMETERISATION

The “Sequence N” tab contains the following parameters:

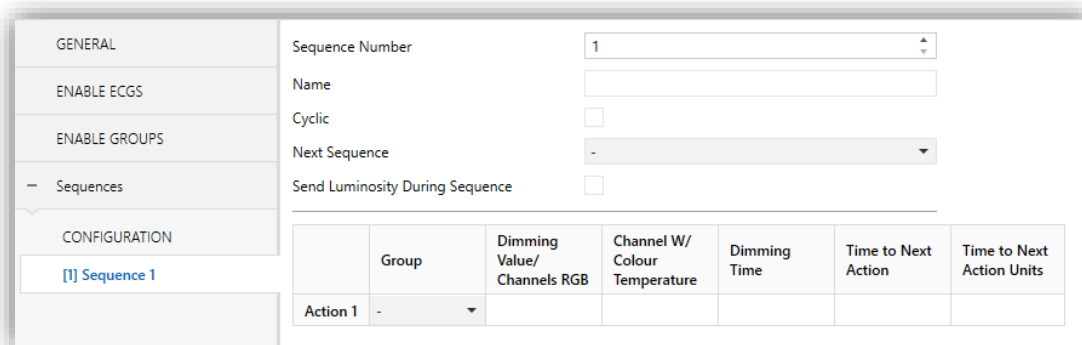

Figure 15. Sequence N

- **Sequence Number** [1...64]: sets the sequence identifying number whose reception through the aforementioned communication objects will make the device trigger the sequence.
- **Name**: 12 characters text that allows set the scene name. That name is displaying in the sequence tab.

- **Cyclic** [*enabled/disabled*]: sets whether the sequence should start over or not after the execution of the last action.
- **Next Sequence** [*No Sequence / Sequence n*]: in case the sequence is not **cyclic**, this parameter allows the execution of another sequence after the last action of the current one.
- **Send Luminosity During Sequence** [*enabled/disabled*]: sets whether the “[Group n] Dimming Value (Status)” object should be sent during the sequence.

Each sequence allows enabling up to **five actions**:

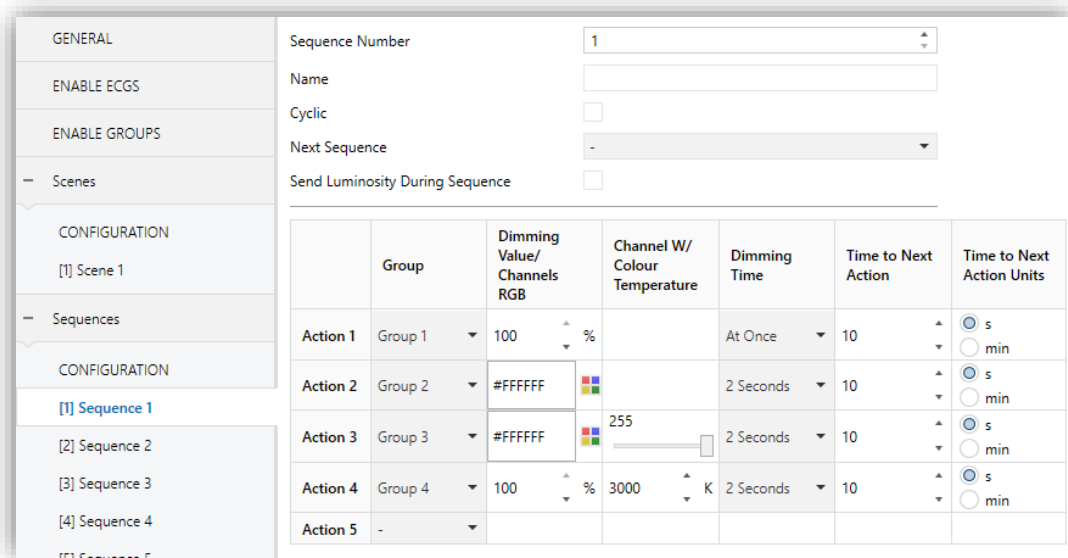

Figure 16. Sequence (example)

- **Action M**: enables action number M and associates it to a particular **group**.

Depending on the option assigned to **Colour Control** parameter, on “Enable Groups” tab (section 2.3), different options can be setting:

➤ **Dimming Value / Channels RGB:**

- Colour Control: “No” → **Dimming Value** [*0...100*][%].
- Colour Control: “RGB” → **Channels RGB** [*#000000...#FFFFFF*].
- Colour Control: “RGBW” → **Channels RGB** [*#000000...#FFFFFF*].
- Colour Control: “Colour Temperature” → **Dimming Value** [*0...100*][%].

➤ **Channel W / Colour Temperature:**

- Colour Control: “RGBW” → **Canal W** [0...255]
- Colour Control: “Colour Temperature” → **Colour Temperature** [1000...3000...20000][K].

Note: *if the selected group has not been enabled, the action will have no effect.*

➤ **Dimming Time:**

- Colour Control: “No” → [At Once / Dimming Time 1 / Dimming Time 2 / Dimming Time 3 / Time to Next Action]. In case of selecting “Time to Next Action”, the dimming time –i.e., the total time for a transition from 0% to 100– will match the action time, which is configured through the next parameter.
 - Colour Control: “RGB”, “RGBW”, “Colour Temperature” → **Dimming Time** [At Once / 0.7 Seconds / 1 Seconds / 1.4 Seconds / 2 Seconds / 2.8 Seconds / 4 Seconds / 5.7 Seconds / 8 Seconds / 11.3 Seconds / 16 Seconds / 22.6 Seconds / 32 Seconds / 45.3 Seconds / 64 Seconds / 90.5 Seconds]. This time will be the time from current value to finish value. Only for groups with colour control.
- **Time to Next Action** [1...10...255] [s/min]: defines the length of the action, i.e., the time it will take until the next action begins.

An example of custom sequence configuration is shown in Figure 16.

Important: *in order to avoid action overlapping between groups or within the same group, please configure the **Dimming Time** and the **Time to Next Action** with caution.*

2.6 STANDBY MODE

When enabled, DALI-BOX Interface v2 sends a one-bit object to the KNX to switch off the ballasts of a group once the parameterised time has expired. This allows making use of an external actuator to interrupt the power supply of the ballasts, thus reducing the power consumption. The object will be sent once again (with the inverse value) as soon as the group is switched on again. Note that enabling this function may make the group switch-on last a little longer than expected.

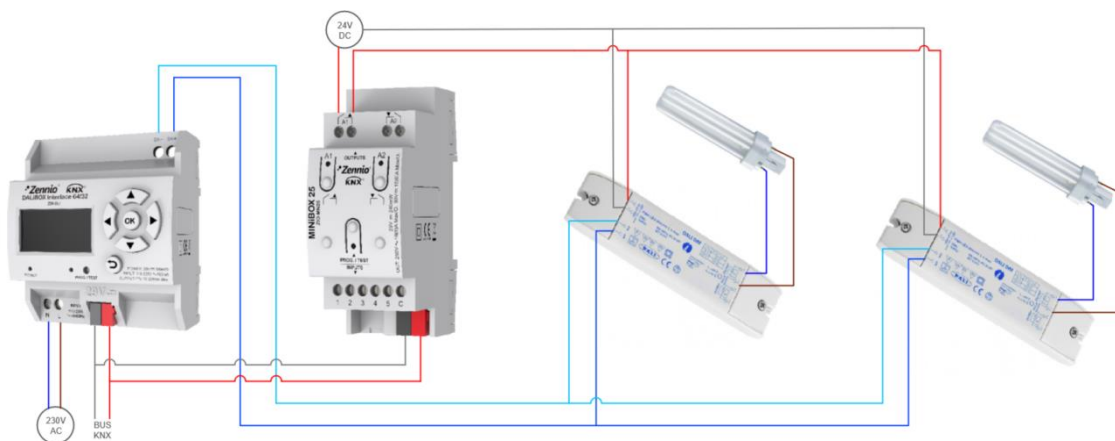

Figure 17. Wiring suggestion for the Standby function

On the other hand, during the device **start-up**, the Standby object will be sent as **inactive** to make it possible that the ballasts are powered during their initialisation. Some other situations imply sending the Standby object:

- A power supply error,
- A short-circuit error,
- The **Burn-In mode** (see section 2.8.11.1). If the Standby function has been enabled, the Burn-In mode will last 600 ms longer, to ensure the ballasts are powered for at least the parameterised burn-in time.
- The **Test On mode** (see section 3.6).
- Running the **DCA DALIBOX Tool**.

It is important to note that this functionality may have certain consequences over ballast replacements or group error detections. For example:

- While the Standby mode remains active (i.e., while the ballast power supply remains interrupted), **DALI-related errors** such as the ballast presence error or the diagnostic errors will no longer be detected.
- During **ballast initialisation** or DALI address assignment, any attempts to activate the Standby mode will be postponed by 30 seconds, as many times as necessary until such process is finished.

The following example illustrates how the Standby mode works:

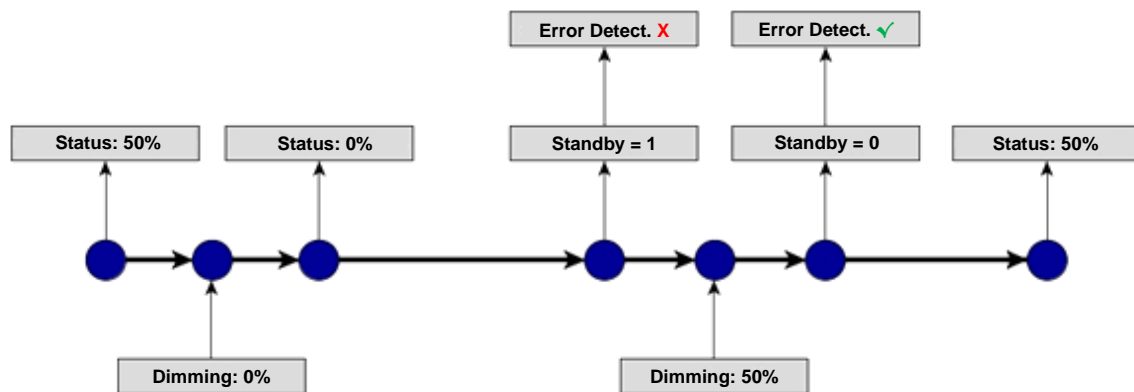

Figure 18. Standby mode action sequence

Important:

- *Ballasts with no group assignment (see section 2.2) should not to be connected to the actuator that interrupts the power supply, as they may cause a ballast presence error notification when the Standby mode gets activated.*
- *Standby mode and emergency ballast are compatible, but this type of ballast should not be switched off as it would go into emergency mode and drain the battery. However, it should avoid set emergency ballast in groups with Standby mode. So that, it is recommended setting the emergency ballast with no group.*
- *Standby mode will not be activated during ECG Detection while any ballast is still not configured.*

ETS PARAMETERISATION

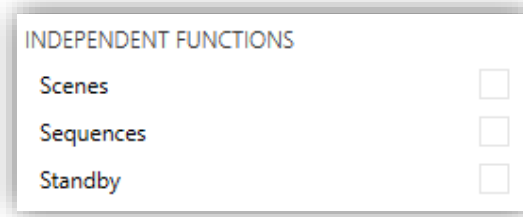

Figure 19. General functions

Once the Standby function is enabled from the **Independent Functions** section in the “General” parameter tab, the “Standby” section will be displayed, where the 16 configurable *Standby* instances are shown.

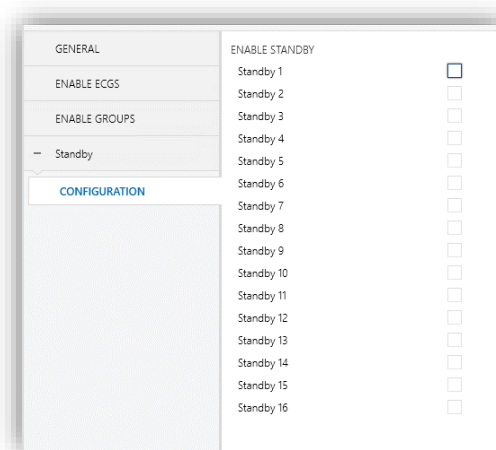
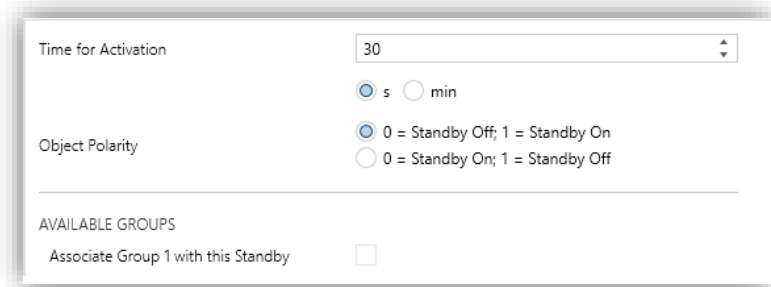

Figure 20. Standby enabling

- **Time for activation** [0...30...255] [s/min]: defines the time ECG needs to be switched off for activating the Standby.
- **Standby Object Polarity** [0 = Standby Off; 1 = Standby On / 0 = Standby On; 1 = Standby Off]: sets value will be sent through “**Standby (Status)**” on the activation and the deactivation of the Standby mode.

Depending on the enabled groups, different associations are available for the enabled standby instance.



Time for Activation: 30

s min

Object Polarity: 0 = Standby Off; 1 = Standby On
 0 = Standby On; 1 = Standby Off

AVAILABLE GROUPS

Associate Group 1 with this Standby

Figure 21. Standby

2.7 NO GROUP

2.7.1 ECG N

Ballasts that have been enabled but have no group assigned yet will still provide some basic configuration options, analogous to those provided by ballasts that do have a group assigned, although none of the functions that can be configured for groups will be available for ballasts without a group.

These basic options are:

- **Name:** name of up to twelve characters that will identify the ballast along the options of the device display, for example during group assignment or for the manual control function.
- **Operating time counter:** function that informs the KNX bus about the operation time, i.e., how much time the ballast has remained under a dimming level greater than 0% since DALI-BOX Interface v2 took over the control of the ballast.
- **Operation Time Initial Value:** sets the value after download.
- **ECG Type:** sets the ECG type.

ETS PARAMETERISATION

When new ballasts with no group assignment become enabled (see section 2.2), new sub-tabs (one per ballast) will be incorporated under the “No Group” tab, providing the following options:

GENERAL	Name	<input type="text"/>
ENABLE ECGS	Enable Operating Time Counter Object	<input type="checkbox"/>
ENABLE GROUPS	Operation Time Initial Value	<input checked="" type="radio"/> Keep Value <input type="radio"/> Defined Value
- No Group	ECG Type	Self-contained Battery Light (Converter)
[!] ECG 1	Value in Emergency Mode	100 %
	Prolong Time on Recovery	0 min
	Function Test Interval	0 days
	Duration Test Interval	0 weeks
	Partial Duration Test Interval	0 weeks
	Partial Duration Test Duration (0 = Disabled)	0 min
	Test Execution Timeout	0 days

Figure 22. No Group – ECG N

- **Name:** desired identifier for the ballast (up to twelve characters).
- **Enable Operating Time Counter Object** [*enabled/disabled*]: enables the “[ECG N] Operating Time” four-byte object, which shows (in seconds, although updated every hour) how much time DALI-BOX Interface v2 has been regulating the ballast with a dimming level greater than 0%. This object can be overwritten to change the value, for example in case of a ballast replacement. It can also be reset by means of the “Installation” menu on the display, as detailed in section 3.
- **Operation Time Initial Value** [*Keep Value / Defined Value*]: defines the initial value after download. Selecting “Defined Value” display the parameter **Value** [*0...596523*] [*h*] which sets de initial value after download.
- **ECG type** [*Normal ECG / Self-contained Battery Light (Converter) / LED Module / Colour Control*]: in case of selecting “Self-contained Battery Light (Converter)”, the following parameters are shown:
 - **Value in Emergency Mode** [*0...100*][*%*]: sets the brightness level of the lamp in emergency mode.

- **Prolong Time on Recovery** [0...20][*min*]: sets the time to remain in the extended emergency mode after main voltage recovery.
- **Function Test Interval** [0...255][*days*]: sets the periodic time for automatic execution of the test which checks the proper function of the converter.
- **Duration Test Interval** [0...52][*weeks*]: sets the periodic time for automatic execution of the test which checks converter is working properly in case of power failure.
- **Partial Duration Test Interval** [0...52][*weeks*]: sets the periodic time for automatic execution of partial duration test. This test checks faster than duration test that, in case of power failure, the battery life is appropriate.
- **Partial Duration Test Duration** [0...60][*min*]: sets the duration time for automatic execution of the partial duration test.
- **Test Execution Timeout** [0...255][*days*]: sets the maximum time after which the function test or duration test must be executed. If a test has not ended within this time the result will indicate max delay exceeded.

2.7.1.1 EMERGENCY TESTS

When “Converter” is selected as ECG Type, the following objects turn visible:

- **[ECG N] Converter Test Control:** Controls a test of a DALI converter. Furthermore, it allows to stop running test and to reset test flags. These object follows the following coding:
 - 0: Reserved.
 - 1: Start function test.
 - 2: Start duration test.
 - 3: Start partial duration test.
 - 4: Stop test.
 - 5: Reset function test done flag.
 - 6: Reset duration test done flag
 - 7 – 255: Reserved.
- **[ECG N] Converter Status:** Returns the status of a converter with the following coding:

DPT	Format												
[244.600]	<table border="1" style="margin-left: auto; margin-right: auto;"> <tr> <td style="text-align: center;">CM</td> <td style="text-align: center;">HS</td> <td style="text-align: center;">FP</td> <td style="text-align: center;">DP</td> <td style="text-align: center;">PP</td> <td style="text-align: center;">CF</td> </tr> <tr> <td style="text-align: center;">NNNN</td> <td style="text-align: center;">BBBB</td> <td style="text-align: center;">NNNN</td> <td style="text-align: center;">NNNN</td> <td style="text-align: center;">NNNN</td> <td style="text-align: center;">NNNN</td> </tr> </table>	CM	HS	FP	DP	PP	CF	NNNN	BBBB	NNNN	NNNN	NNNN	NNNN
CM	HS	FP	DP	PP	CF								
NNNN	BBBB	NNNN	NNNN	NNNN	NNNN								
<p>CM: <i>Converter Mode</i>. Indicates converter status:</p> <ul style="list-style-type: none"> 0: Unknown. 1: Normal mode active. 2: Inhibit mode active: for 15 minutes the converter will not switch the emergency lighting on when a power failure occurring. 3: Hardwired inhibit mode active: digital input that the converter can have to activate the inhibit mode. 4: Rest mode active: forced off emergency lighting during emergency mode. 5: Emergency mode active. 6: Extended emergency mode active. 7: FT in progress. 8: DT in progress. 9: PDT in progress. 10 - 15: Reserved. 													
<p>HS: <i>Hardware Status</i>. Indicates hardware status:</p> <ul style="list-style-type: none"> 0: Unknown. 1: <i>Hardwired Inhibit</i> is on . 2: Hardwired switch is on: digital input that the converter can have to switch its light on or off when normal mode is activated. 3: <i>Hardwired Inhibit & Hardwired switch</i> is on. 4 - 15: Reserved. 													
<p>FP, DP y PP: <i>Function Test Pending / Duration Test Pending / Partial Duration Test Pending</i>. Indicates if there are any pending test:</p> <ul style="list-style-type: none"> 0: Unknown. 1: No function, duration, partial duration test pending. 2: Function, duration, partial duration test pending. 3: Reserved. 													
<p>CF: <i>Converter Failure</i>. Indicates if there are any failure:</p> <ul style="list-style-type: none"> 0: Unknown. 1: No failure detected. 2: Failure detected. 3: Reserved. 													

- **[ECG N] Converter Test Result:** Returns the result of the last converter test with the following coding:

DPT	Format													
[245.600]	LTRF	LTRD	LTRP	0	0	0	0	SF	SD	SP	0	0	LDTR	LPDTR
	NNNNNNNN	NNNN	r	r	r	r	NNNNNN	r	r	UUUUUUUUUU	UUUUUUUUUU	UUUUUUUUUU	UUUUUUUUUU	UUUUUUUUUU

LTRF, LTRD, LTRP: *Last Test Result Functional / Duration / Partial duration:* Indicates the test result of each type:

- 0: Unknown.
- 1: Passed in time.
- 2: Passed max delay exceeded.
- 3: Failed, test executed in time.
- 4: Failed, max delay exceeded.
- 5: Test manually stopped.
- 6 - 15: Reserved.

SF, SD, SP: *Start method of last Functional / Duration / Partial test.* Indicates the method by which the last test started. Updated when a test is finish.

- 0: Unknown.
- 1: Started automatically.
- 2: Started by Gateway.
- 3: Reserved.

LDTR: *Last Duration Test Result.* Contains the battery discharge time as the result of the last successful duration test indicated in minutes.

LPDTR: *Last Partial Duration Test Result.* Provides the remaining battery charge level after the last partial duration test.

- 0: Deep discharge point.
- 1 - 253: Battery level..
- 254: Fully charged.
- 255: Unknown.

Note: *if different test requests are sent, these requests are cumulated by performing each one. However, duration tests and partial duration tests are not cumulative, so either one or the other is performed.*

2.8 GROUP N

2.8.1 CONFIGURATION

The general configuration for each group involves the following options:

- **Group name:** name of up to twelve characters that will identify the group along the options of the device display.
- **Dimming value during DALI bus failure:** sets the dimming level that will be adopted by the ballasts of the channel if communication errors take place between DALI-BOX Interface v2 and the ballasts, which may be due to **short-circuits** or to a **power supply failure**.

Note: *during the absence of the KNX bus, on the contrary, DALI-BOX Interface v2 will keep powering the DALI groups (even if the external power LED indicator remains off). Against this situation, the ECGS take the value configuring on **Dimming Value During KNX Bus Failure** (see section 2.1). Note that timed actions will be stopped and will not be resumed when the KNX bus voltage is recovered.*

- **Functions:** configuring a set of custom functions per group is possible:
 - **Status objects:** allows enabling or disabling the status objects associated to each channel (On/Off and dimming value). See section 2.8.4.
 - **Custom On/Off:** allows enabling two custom On/Off controls, with different dimming values and times. See section 2.8.5.
 - **Day/Night Mode:** sets an alternative switched and allows change between two modes. See section 2.8.6.
 - **Timers:** allows defining timed or delayed on/off switches. See section 2.8.7.
 - **Lock:** enables a lock object, which allows locking and unlocking the group, i.e., disabling the control. See section 2.8.8.
 - **Alarm:** allows the possibility of configuring an **alarm action** over the output group, which will be executed on the arrival of a specific trigger object from the bus. See section 2.8.9.

- **Custom initialisation:** permits setting the initial state of the ballasts in the group (or after a KNX bus failure). See section 2.8.10.
- **Modes:** allows enabling and configuring different operation modes: Auto Off and Burn-in. See section 2.8.11.
- **Regulation:** the ballast regulation type and power output curve can be configured as logarithmic or as linear.

ETS PARAMETERISATION

As new groups are enabled (see section 2.3), additional sub-tabs will be incorporated with name “Group N”, being N their specific numbers. These tabs, on their side, contain a set of new sub-tabs. The first one, “Configuration”, provides the following parameters:

Figure 23. Group 'N'. Configuration

- **Name:** desired identifier for the group (up to twelve characters).
- **Diming Value During DALI Bus Failure** [*Off / Defined Vale / No Change*]: in case of selecting “Defined Value” the ballast will switch to a customisable value [*0...100*] [%].
- **Functions:** checkboxes to enable additional functions for the group:
 - **Status Objects** [*enabled/disabled*].

- **Custom On/Off** [[enabled/disabled](#)].
- **Day/Night Mode** [[enabled/disabled](#)].
- **Timers** [[enabled/disabled](#)].
- **Lock** [[enabled/disabled](#)].
- **Custom Initialisation** [[enabled/disabled](#)].
- **Modes** [[enabled/disabled](#)].

● Regulation:

- **Ballast Regulation Type** [[Logarithmic / Linear](#)]: sets the ballast regulation type.
- **Colour Channels Curve** [[Logarithmic / Linear](#)]: defines the dimming curve which will be applied to RGB and RGBW colour groups.
- **Power Output Curve** [[Logarithmic / Linear](#)]: defines the power curve that will be applied to ballast to get different dimming effects.

In case groups with no colour, both parameters work together in order to display the desired visual effects. The Table 5 displays the different options:

Ballast Regulation	Power Curve	Visual Effect
Logarithmic	Logarithmic	Linear
Logarithmic	Linear	Antilogarithmic
Linear	Logarithmic	Linear
Linear	Linear	Antilogarithmic

Table 5. Regulation Options

On the other hand, the parameters are independent for RGB / RGBW groups, so the colour channel curve will be applied only to the colour components, and the power curve will be applied to the control component.

Note: *linear regulation is compatible with LED modules only. In case of enabling this option, a warning message shows up in ETS.*

2.8.2 LIMITS

DALI-BOX Interface v2 allows configuring two different limit types:

- **Luminosity Limits:** they limit the luminosity ranges controlled by the ballast. These limits are not perceptible by the user, i.e., the dimming range for the KNX bus will still be 0-100%, and the dimming time between both ends (0% to 100%) will be exactly the dimming time parameterised.
 - **Ballast Physical Minimum:** minimum luminosity value that the ballast is actually able to produce, as specified by the manufacturer. This determines the actual luminosity level that will correspond to a dimming percentage of 1%.

***Note:** physical minimum must be configured as indicated in the ballast or in the datasheet.*
 - **Economic Mode:** maximum luminosity level the ballast will be allowed to reach. It determines the actual luminosity level that will correspond to a dimming percentage of 100%.
- **Dimming Limits:** perceptible limits that allow restricting the percentage value range of the control objects. Note that the actual meaning of the values of these objects depends itself on the luminosity limits configured. The effect of these limits over the dimming times is explained in section 2.1.
 - **Minimum Dimming Value:** lower dimming percentage allowed. The load will remain at this level in case of receiving a lower value (only switch-off orders will be handled).
 - **Maximum Dimming Value:** upper dimming percentage allowed. The load will remain at this level in case of receiving a greater value.

The dimming curve considers all the above limits.

ETS PARAMETERISATION

The “Limits” tab provides the following options:

Figure 24. Limits

● Luminosity Limits:

- **Ballast Physical Minimum** [[enabled/disabled](#)]: enables or disables the physical minimum for the ballasts of the group.
 - **Minimum Luminosity Level** [[1...10...100](#)][[x 0.1%](#)].
- **Economical Mode** [[enabled/disabled](#)]: enables or disables the economic mode.
 - **Maximum Luminosity Level** [[100...1000](#)][[x 0.1%](#)].

● Dimming Limits:

- **Minimum Dimming Value** [[0...100](#)][[%](#)].
- **Maximum Dimming Value** [[0...100](#)][[%](#)].

2.8.3 SWITCH & DIMMING

DALI-BOX Interface v2 lets configuring the general On/Off switch control so that these actions are performed **immediately** or through a **smooth regulation** (according to one of the three configurable dimming times detailed in section 2.1).

Furthermore, it is possible to specify the luminosity level that the group will adopt when a general switch-on order is executed: either a **fixed value** (configurable in parameters) or the **last value** prior to the switch-off (i.e., a memory switch-on). In addition, in case of

selecting the latter, it is possible to select whether a **second switch-on order** should set the maximum dimming value.

DALI-BOX Interface v2 provides two general dimming controls besides the general On/Off control:

- **Relative Dimming:** modifies the dimming level through orders to increment or decrement it by fixed percentages (“1.6%”, “3.1%”, “6.3%”, “12.5%”, “25%”, “50%” or “100%”), which will be added to or subtracted from the current dimming level of the group. A **four-bit object** is provided for the reception of the relative dimming orders.

It is possible to select whether it will be possible to switch on and/or switch off a group through a relative dimming order, in case the target value is lower than the minimum parameterised. If switch off is not enabled, the group will remain at the minimum level parameterised and if switch on is enabled the load will remain at minimum dimming value.

- **Absolute dimming:** modifies the dimming level through orders that specify the desired target value, regardless of the current value of the group. A **one-byte object** is provided for the reception of the absolute dimming orders.

For both dimming modes, the dimming time for the 0% to 100% transition may be selected among the three different dimming times already defined. An immediate transition can also be configured, if desired.

Note: *in case of configuring dimming limits (see section 2.8.2), they will be applied as follows:*

- *Transitions between 0% and the minimum dimming value will be instantaneous.*
- *Transitions between the minimum dimming value and the maximum dimming value will take the proportional part of the parameterised dimming time (which must be understood as the time corresponding to the entire transition from 0% to 100%).*

ETS PARAMETERISATION

The following parameters are available in the “Switch & Dimming” tab:

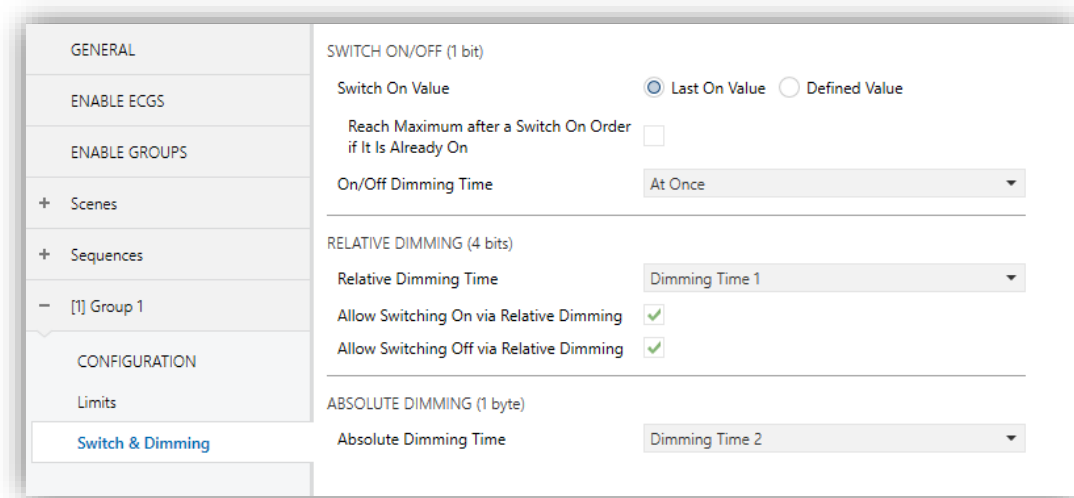

Figure 25. Switch & Dimming

● Switch On/Off (1 bit):

- **Switch-On Value** [[Last On Value](#) / [Defined Value](#)]: allows selecting the general dimming level that will be adopted by the group when the value “1” is received through “[Group n] On/Off”. The dimming level will be applied when sending a switch on value, with the group switched on or off.
 - In case of selecting “[Last On Value](#)”:
 - **Reach maximum after a switch-on order if it is already on** [[enabled/disabled](#)]: when enabling this option, if the group is already switched on when receiving the value “1”, the dimming level will reach the maximum configured value.
 - In case of selecting “[Defined Value](#)”, and depending on the option assigned to **Colour Control** parameter, on “Enable Groups” tab (section 2.3):
 - Colour Control: “[No](#)” → **Dimming Value** [[0...100](#)][%].
 - Colour Control: “[RGB](#)” → **Channels** **RGB** [[#000000...#FFFFFF](#)].
 - Colour Control: “[RGBW](#)” → **Channels** **RGB** [[#000000...#FFFFFF](#)] / **Channel W** [[0...255](#)].

- Colour Control: “Colour Temperature” → **Dimming Value** [0...100][%] / **Colour Temperature** [1000...3000...20000][K].
- **On/Off Dimming Time** [At Once / Dimming Time 1 / Dimming Time 2 / Dimming Time 3].
- **Relative Dimming (4 bits)**: allows setting up the configuration of the relative dimming function and the **four-bit** object “[Group n] Relative Dimming”.
 - **Relative Dimming Time** [At Once / Dimming Time 1 / Dimming Time 2 / Dimming Time 3].
 - **Allow Switching On via Relative Dimming** [enabled/disabled]: sets whether the group, which has previously off, should be switched on in case an order with a relative dimming value.
 - **Allow Switching Off via Relative Dimming** [enabled/disabled]: sets whether the group should be switched off in case a decrease order with a dimming value lower than the minimum value parameterised is received.
- **Absolute Dimming (1 byte)**: this section allows setting up the configuration of the relative absolute dimming function and the **one-byte** object “[Group n] Absolute Dimming”.
 - **Absolute Dimming Time** [At Once / Dimming Time 1 / Dimming Time 2 / Dimming Time 3].

2.8.4 STATUS OBJECTS

DALI-BOX Interface v2 provides different objects that report the current dimming state of the output group. The objects shown will depend on the parameterization of the tabs "Enable Groups" (section 2.3) and "Colour control" (section 2.8.12):

- A **one-bit object** (On/Off).
- A **one-byte object**, which indicates the dimming level (in percentage).
- A **three-bytes object**, which indicates the RGB dimming level.
- A **three-bytes object** and a **one-byte object** or **six-byte object**, which indicate the RGBW dimming level.
- A **two-bytes object**, which indicates the colour temperature dimming level.

ETS PARAMETERISATION

After enabling this function, the following options will be available in “Status Objects” tab:

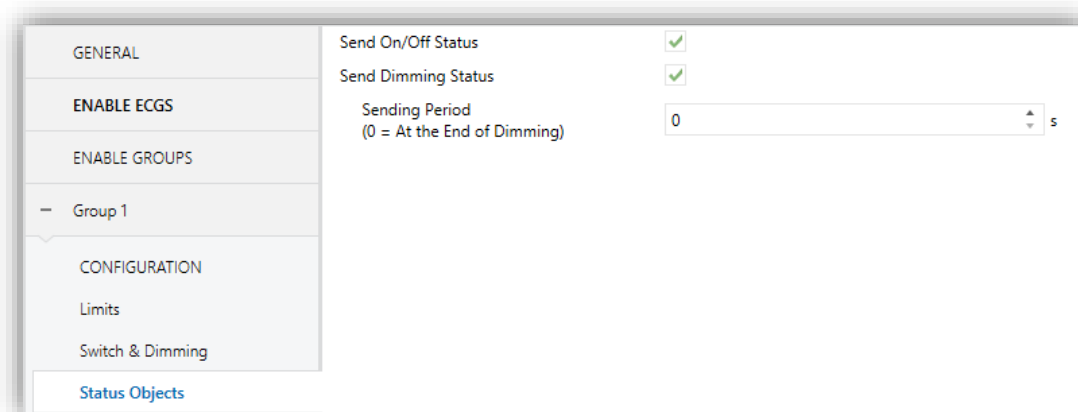

Figure 26. Status Objects

- **Send On/Off Status** [[enabled/disabled](#)]: enables sending a one-bit object (“**[Group n] On/Off (Status)**”) whenever the group is switched off (“0”) or on (“1”).
- **Send Dimming Status** [[enabled/disabled](#)]: enables certain objects depending on the option assigned to **Colour Control** parameter, on “Enable Groups” tab (section 2.3):
 - Colour Control: “No”, “RGB”, “RGBW”, “Colour Temperature” → “**[Group n] Dimming Value (Status)**”: will be sent with the current dimming value of the group (between 0% and 100%) whenever it changes.
 - Colour Control: “RGB”, “RGBW” → “**[Group n] Channels RGB Dimming Value (Status)**”: 3-byte object that will send the RGB dimming value whenever it changes.
 - Colour Control: “RGBW” → “**[Group n] Channels W Dimming Value (Status)**” and “**[Group n] Channels RGBW Dimming Value (Status)**”: 1 and 6-byte objects that will send the W and RGBW dimming value, respectively.

Enabling this parameter brings up an addition one:

- **Sending Period** [[0...255](#)] [s]: defines the sending cycle time of the status object during a dimming process. If it is set to “0”, the dimming status will be sent only at the end of the dimming process.

2.8.5 CUSTOM ON/OFF

This function offers one additional On/Off control for each group, and therefore another new communication object to switch the ballasts on and off.

This additional control can be customised with specific dimming levels for the “On” and “Off” states and may also be configured to perform an immediate or soft dimming.

ETS PARAMETERISATION

Once the function has been enabled, the “[Group n] Custom On/Off” one-bit object and a specific parameter tab will show in ETS:

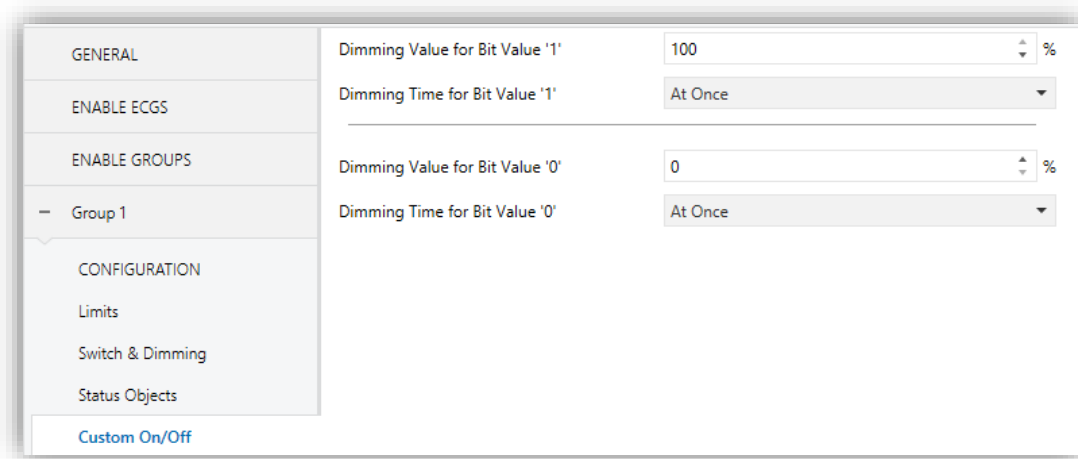

Figure 27. Custom On/Off

This new screen allows setting up the specific behaviour when a “1” or a “0” are received through the aforementioned object:

- **Dimming Value for Bit Value ‘1’** [0...100] [%]: sets a specific dimming percentage to be applied to the group when a “1” is received.
- **Dimming Time for Bit Value ‘1’** [At Once / Dimming Time 1 / Dimming Time 2 / Dimming Time 3].
- **Dimming Value for Bit Value ‘0’** and **Dimming Time for Bit Value ‘0’**: analogous to the above two parameters but referred to the arrival of the value “0” from the bus.

2.8.6 DAY/NIGHT MODE

In addition to custom On/Off, DALI-BOX Interface v2 offers the control known as Day/Night Mode. This control enables the ballast to be switched On and Off using a one-bit object and to change between two lighting modes by means a different one-bit object.

ETS PARAMETERISATION

Enabling this option displays two one-bit objects “[Group n] Day/Night Mode” and “[Group n] Day/Night Mode On/Off” and adds the corresponding configuration tab:

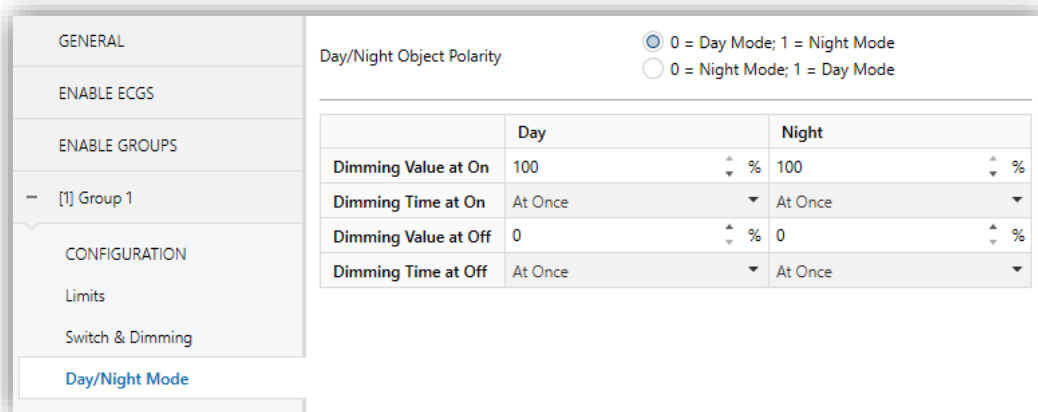

Figure 28. Day/Night Mode.

This tab sets the dimming levels will be applied over the ballast when an “On” or “Off” is received through “[Group n] Day/Night Mode On/Off” object depending on active mode. Active mode can be changed using “[Group n] Day/Night Mode” object.

- **Day/Night Object Polarity** [0 = Day Mode; 1 = Night Mode / 0 = Night Mode; 1 = Day Mode]: sets which value active each mode.
- **Dimming Value at On** [0...100][%]: sets the level ballast group will get when DALI-BOX Interface v2 receives “On” through “[Group n] Day/Night Mode On/Off” for each mode.
- **Dimming Time at On** [At Once / Dimming Time 1 / Dimming Time 2 / Dimming Time 3].
- **Dimming Value at Off** [0...100][%]: sets the level ballast group will get when DALI-BOX Interface v2 receives “Off” through “[Group n] Day/Night Mode On/Off” for each mode.
- **Dimming Time at Off** [At Once / Dimming Time 1 / Dimming Time 2 / Dimming Time 3].

2.8.7 TIMERS

This function allows configuring a **simple timer** and a **flashing sequence** in the output group, being it possible to enable or disable both functions independently.

- The **simple timer** function consists in a switch-on of the group (with an optional delay) on the reception of the corresponding trigger object, and a later switch-off, either automatic (after a certain period) or triggered through the corresponding bus object, also with an optional delay in this case.
- On the other hand, the **flashing** function consists in switching the group on and off a certain number of times or indefinitely, according to the parameters, once the corresponding object is received.

ETS PARAMETERISATION

After enabling this option, the following parameters will show in ETS:

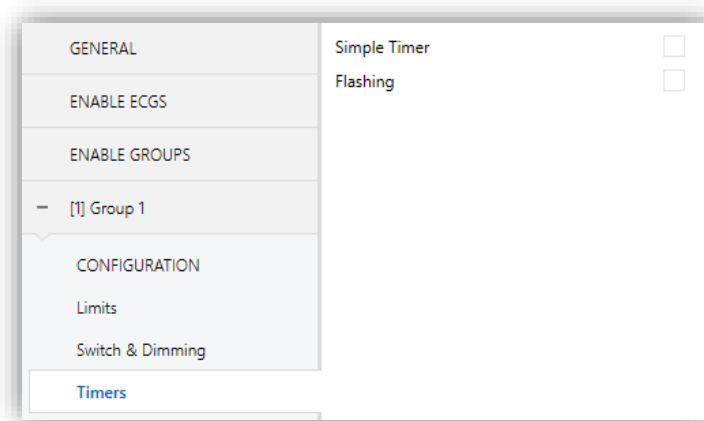

Figure 29. Timers

Simple Timer and **Flashing** are disabled by default. Once enabled, the “[Group n] Simple Timer” and “[Group n] Flashing” one-bit objects are added to the project topology. An additional parameter tab for each option shows up too, as described next.

2.8.7.1 SIMPLE TIMER

The simple timer function requires configuring the following options:

- **On Duration:** time the group must remain on before being automatically switched off (unless the stop order is received from the bus, which will switch the group off immediately).

- **On Delay:** delay between the reception of the simple timer trigger order and the actual switch-on of the group.
- **Off Delay:** delay between the reception of the simple timer stop order and the actual switch-off of the group.
- **Action in Case of Retriggerring:** action to be performed in case the simple value trigger order is received several times.
 - **Nothing:** the current time count will not be restarted.
 - **Restart:** the part of the timer that is running will restart its counter from zero.
 - **Multiply:** the part of the timer that is running will be multiplied by 'n', being 'n' the number of times the value "1" is received (up to 5 times).
- **On Value:** dimming level to be applied to the group during the "on" stage.
- **Dimming Time:** desired regulation type for the transitions.

Note: *the simple timer function will be interrupted whenever any other dimming action is commanded, no matter if it falls within the On Duration or during the On/Off delays.*

ETS PARAMETERISATION

Once the simple timer function has been enabled, the "[Group n] Simple Timer" one-bit object becomes enabled too, making it possible to trigger a switch-on by sending it the value "1" or a switch-off by sending it the value "0". Both actions can be delayed according to the following parameters:

GENERAL	On Duration (0 = Endless)	0
ENABLE ECGS		<input checked="" type="radio"/> s <input type="radio"/> min
ENABLE GROUPS	On Delay (0 = No Delay)	0
Group 1		<input checked="" type="radio"/> s <input type="radio"/> min
CONFIGURATION	Off Delay (0 = No Delay)	0
Limits		<input checked="" type="radio"/> s <input type="radio"/> min
Switch & Dimming	Action in Case of Retriggerring	Nothing
Timers	On Value	100 %
Simple Timer	Dimming Time	At Once

Figure 30. Simple Timer

- **On Duration** [0...255][s/min]: sets the time the group will remain on. The value “0” will disable the automatic switch-off, thus making the group remain on.
- **On Delay** [0...255][s/min]: sets a delay after the reception of value “1” through object “[Group n] Simple Timer”.
- **Off Delay** [0...255][s/min]: sets a delay after the reception of value “0” through object “[Group n] Simple Timer”.
- **Action in Case of Retriggering** [Nothing / Restart / Multiply] sets the action to be performed in case the value “1” is received several times.
- **On Value** [1...100][%]: sets the specific dimming percentage to be applied to the group during the “on” stage.
- **Dimming Time** [At Once / Dimming Time 1 / Dimming Time 2 / Dimming Time 3].

2.8.7.2 FLASHING

The flashing function requires configuring the following options:

- **On Duration**: length of each “On” stage during the sequence.
- **Off Duration**: length of each “Off” stage during the sequence.
- **Repetitions**: number of iterations of the sequence.
- **On Value**: dimming level to be applied to the group during the “On” stages.
- **Final Value**: dimming level to be applied to the group after the last repetition or after the reception.

PARAMETRIZACIÓN ETS

Once the flashing function has been enabled, the “[Group n] Flashing” one-bit object will turn visible in order to let triggering an On-Off-On... sequence by sending it the value “1”, as well as interrupting it by sending it the value “0” The options for this function are the following:

GENERAL	On Duration	1
ENABLE ECGS		<input checked="" type="radio"/> s <input type="radio"/> min
ENABLE GROUPS	Off Duration	1
Group 1		<input checked="" type="radio"/> s <input type="radio"/> min
CONFIGURATION	Repetitions (0 = Endless)	0
Limits	On Value	100 %
Switch & Dimming	Final Value	0 %
Timers		
Simple Timer		
Flashing		

Figure 31. Flashing

- **On Duration** [1...255][s/min]: sets the length of each “On” stage.
- **Off Duration** [1...255][s/min]: sets the length of each “Off” stage.
- **Repetitions** [0...100]: sets the number of iterations of the sequence. A value of “0” (default option) causes an endless repetition, until an order to interrupt the sequence is received.
- **On Value** [1...100][%]: sets a specific dimming percentage to be applied to the group during the “On” stages.
- **Final Value** [0...100][%]: sets a specific dimming value to be applied to the group after the last repetition or after the reception of one “0” through the “[Group n] Flashing” communication object.

2.8.8 LOCK

Enabling the lock function will bring a **one-bit** object which will allow locking and unlocking the group. Group locking causes that any bus orders addressing to that group are ignored.

Receiving a lock order while running a sequence, a flashing sequence or a timed action **will stop the execution of that action.**

ETS PARAMETERISATION

Once this function has been enabled, the following options will show in ETS:

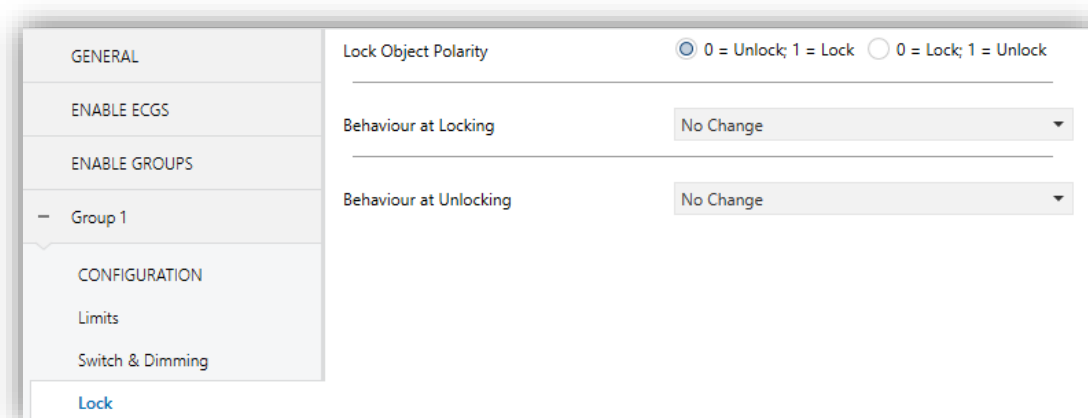

Figure 32. Lock

- **Lock Object Polarity** [0 = Unlock; 1 = Lock / 0 = Lock; 1 = Unlock]: sets which value will be interpreted as a lock order and which one as an unlock order.
- **Behaviour at Locking** [No Change / Off / On / Defined Value]: sets the action to be performed when a lock order is received. In case of selecting “Defined Value”, the **value** [0...100] [%] will be parameterisable.
- **Behaviour at Unlocking** [No Change / Off / On / Defined Value / Previous State]: sets the action to be performed when an unlock order is received. The options are analogous to those for locking but will also comprise the following one: “Previous State” (to recover the status previous to the lock order).

2.8.9 ALARM

This function brings the possibility of configuring an **alarm action** over the output group, which will be executed on the arrival of a specific trigger object from the bus. Moreover, the activation of the alarm will interrupt any timed action that is in progress (simple timers, flashing and sequences).

There is the possibility of **cyclical monitoring**, with a period to be chosen by the user. If enabled, the alarm will not only be activated if the trigger with the parameterized value is received, but also in case the no-alarm value is not received at least once within the configured cycle time.

Regarding the **alarm deactivation**, can be either normal or frozen (i.e., through an acknowledgement):

- **Normal:** the device leaves the alarm state as soon as the no-alarm value is received.
- **Frozen:** after the arrival of the no-alarm value, an additional acknowledgement object must be received before the device leaves the alarm state.

Any light regulation orders received during the alarm state will be ignored.

ETS PARAMETRERISATION

A specific alarm action can be configured per group. Once this function has been enabled, the “Alarm” tab shows up.

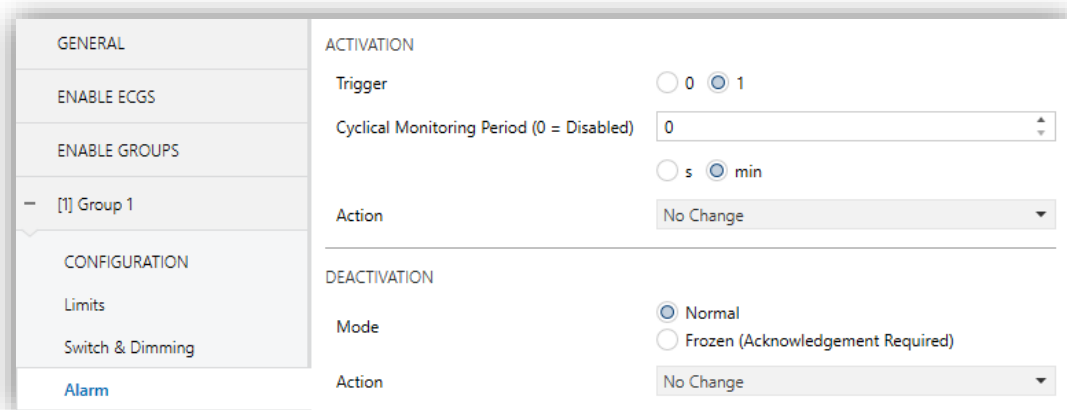

Figure 33. Alarm

The parameters involved in the **alarm activation** are:

- **Trigger** $[0/1]$: sets which value will imply the alarm activation when this value is received through the “[Cx] Alarm” object, then the device will execute the corresponding action.
- **Cyclical Monitoring Period** $[0...600]$ [ds] / $[0...3600]$ [s] / $[0...1440]$ [min] / $[0...24]$ [h]: sets the maximum time without receiving the no-alarm value before the alarm is automatically active. Value “0” disables the alarm cyclical monitor.
- **Action** $[No\ Change / On / Off / Defined\ Value]$: sets the desired response to the alarm activation. If the selected option is “Defined Value”, the additional parameter **Dimming Value** $[0...100]$ [%] will be displayed, to set the desired switch on level.

On the other hand, the parameters involved in the **alarm deactivation** are:

- **Mode** [[Normal](#) / [Frozen \(Acknowledgement Needed\)](#)]: sets the alarm deactivation procedure. When opting for the second option, object “[Cx] **Unfreeze Alarm**” will be included into the project topology for the reception of the acknowledgement messages (value “1”).
- **Action** [[No Change](#) / [On](#) / [Off](#) / [Defined Value](#) / [Previous State](#)]: sets the desired response to the alarm deactivation. If “[Defined Value](#)” is selected, the additional parameter **Dimming Value** [[0...100](#)][%] is displayed, to set the desired switched-on level.

2.8.10 CUSTOM INITIALISATION

This function lets customising the state of the group after the start-up of the device.

Opting for the **default initial configuration** implies the following:

- After an ETS download, the ballasts of the group will remain off.
- After recovering from a KNX bus power failure, the ballasts of the group will recover their state previous to the power failure.

On the other hand, opting for a **custom initial configuration** allows parameterising the desired state after the bus power is restored or after a download.

Note: *KNX bus failures do not switch off the ballasts unless their own power supply is interrupted.*

ETS PARAMETERISATION

Once the option to customise the initial configuration has been enabled (otherwise, the default configuration will be applied) the following parameters will show in ETS:

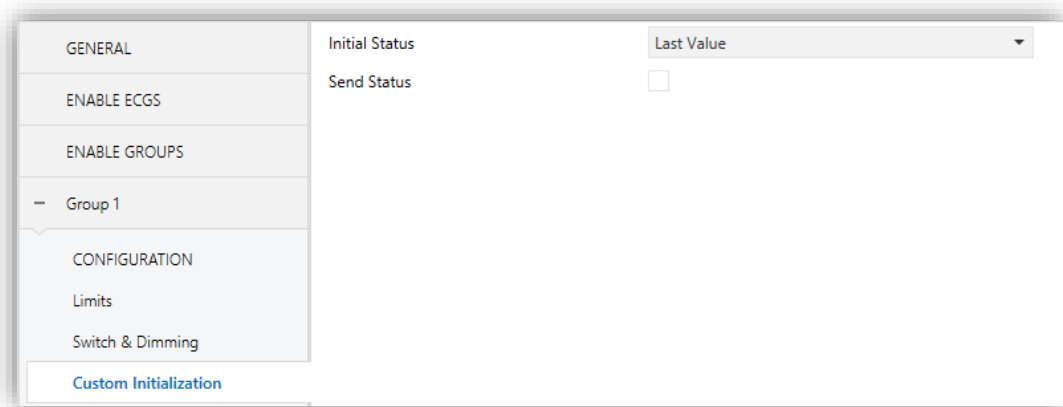

Figure 34. Custom initialisation

- **Initial Status:** sets the desired initial state of the group:
 - Last Value: when the KNX bus power is restored, the group will recover the dimming state previous to the bus failure. Note that this option has no effect after a download (the group will remain off).
 - Off: the group will always start switched off.
 - Defined Value: the group will start at a specific dimming level, configured in **Value** [0...100] [%].
- **Send Status** [enabled/disabled]: if enabled, the status objects will be sent to the bus at the start-up to inform about the initial state of the group. This requires that the status objects have been enabled (see section 2.8.4).
 - **Delay** [0...255] [s]: sets a delay before performing this sending.

2.8.11 MODES

DALI-BOX Interface v2 implements two special operation options named as **Burn-in mode** and **Auto-Off mode**, each of which is explained in detail next.

2.8.11.1 AUTO OFF MODE

The Auto Off mode allows an automatic switch-off of the group if it is found to be steady (i.e., without receiving further dimming orders) under a certain dimming value –or threshold– for at least a certain amount of time (configurable).

This function will not take place while any of the following is active:

- Power supply error.
- Short-circuit error.
- Test On mode.
- Lock.
- Burn-in mode.
- Timers.

ETS PARAMETERISATION

Once the Modes option has been enabled, the following parameters regarding the Auto Off function will show in ETS:

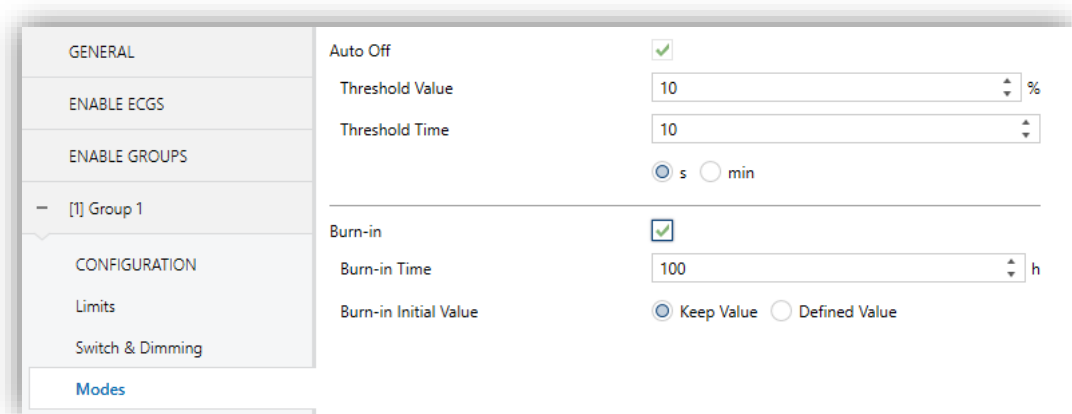

Figure 35. Modes

- **Auto Off** [enabled/disabled]: allows enabling the Auto Off function.
 - **Threshold Value** [1...10...100] [%]: dimming value beneath which the Auto Off will be triggered in case the group remains steady at that value for more than the threshold time.
 - **Threshold Time** [1...10...50] [s/min]: time count before triggering the Auto Off mode.

2.8.11.2 BURN-IN MODE

The Burn-in mode is intended for certain lamp types (such as fluorescent lighting) which need to remain on for a certain time period **before performing any light dimming**. To that end, before the ballasts of the group have been (steadily) switched on for at least

the configured time, it will only be possible to **switch the loads off or to regulate them to 100%**.

In case of having configured any **limits** (either luminosity limits or dimming limits; see section 2.8.2), they will not be considered while the Burn-in mode is in operation, i.e., the loads will be actually switched on entirely. However, they will be applied once the Burn-in mode is over, which will may be perceived as a slight change in the light level.

This functionality entails certain effects over other functions (while the Burn-in mode remains active, any dimming order greater than 0% will be executed as an immediate regulation to 100%, or to 0% in other case):

- Relative and absolute dimming.
- Simple timers and flashing.
- Lock/unlock actions.
- Initialisation.
- Installation test (see section 3).
- DALI bus failure (see section 2.8.1).

An object is provided to force the activation or deactivation of the Burn-in mode at any time.

ETS PARAMETERISATION

Once the Modes option has been enabled, the following parameters will show in ETS:

GENERAL	Auto Off	<input checked="" type="checkbox"/>
ENABLE ECGS	Threshold Value	10 %
ENABLE GROUPS	Threshold Time	10
- [1] Group 1		<input checked="" type="radio"/> s <input type="radio"/> min
CONFIGURATION	Burn-in	<input checked="" type="checkbox"/>
Limits	Burn-in Time	100 h
Switch & Dimming	Burn-in Initial Value	<input checked="" type="radio"/> Keep Value <input type="radio"/> Defined Value
Modes		

Figure 36. Modes

- **Burn-in** [*enabled/disabled*]: allows enabling the Burn-in function. In such case, two new objects become available:
 - “[**Group n**] **Burn-in Mode (Status)**”, which will be sent when the group enters (value “1”) or leaves (value “0”) the Burn-in mode.
 - “[**Group n**] **Burn-in Mode**”, which allows forcing the activation (value “1”) or deactivation (value “0”) of the Burn-in mode at any time, as well as restarting the time count in case it is already active.
 - “[**Group n**] **Burn-in Mode Time**”, which sets how long the Burn-in mode will remain active, in seconds, without a new downloading.

The following parameters will also be available:

- **Burn-in Time** [*1...100...255*] [*h*]: sets the time the Burn-in mode should last.
- **Burn-in Initial Value** [*Keep Value / Defined Value*]: defines the initial value of the hour counter after downloading. Selecting “Keep Value” will maintain the elapsed burn-in time and the group status before downloading. Selecting “Defined Value” will display the **Burn-in Remaining Time** [*1...255*][*h*] parameter which defines the time until the end of Burn-in after download.

2.8.12 COLOUR CONTROL

DALI-BOX Interface v2 allows controlling colour ballast (following DALI Standard, DT8): RGB, RGBW and Colour Temperature ballasts.

This functionality can be enabled for each group individually, so that each group can control a particular type of ballast. For more details, consult section 2.3.

Notes:

- *Take in account that this functionality is only available for compatible ballasts, so connecting a non-colour ballast in a colour group can produce dimming issues.*

- Due to DALI limitations, every colour dimming has a settled time of 2 seconds from start value to finish value (except the sequences, see section 2.5). This applies to the following objects
 - “[Group n] Channels RGB Absolute Dimming”
 - “[Group n] Channels W Relative Dimming”
 - “[Group n] Channels W Absolute Dimming”
 - “[Group n] Channels RGBW Absolute Dimming”
 - “[Group n] Colour Temperature Relative Dimming”
 - “[Group n] Colour Temperature Absolute Dimming”

2.8.12.1 COLOUR CONTROL: RGB

The RGB colour control enables the three channel colour ballasts (RGB) to be managed by two 3-byte objects, “[Group n] Channels RGB Absolute Dimming ” and “[Group n] Channels RGB Dimming Value (Status)”, which enable the DALI-BOX Interface v2 to receive control commands and send statuses, respectively. The status object is displayed or not, depending on the settings in “Status objects” (section 2.8.4).

Note: selecting RGB control does not displayed an extra tab on ETS.

2.8.12.2 COLOUR CONTROL: RGBW

The RGBW colour control enables the four channel colour ballasts (RGBW) to be controlled.

Control over this type of ballasts can be carried out by a six-bytes object or three independent objects, one for RGB and two for W.

ETS PARAMETERISATION

Once colour option has been selected as “RGBW”, on “Enable Groups” tab (section 2.3), the following parameters will show in ETS:

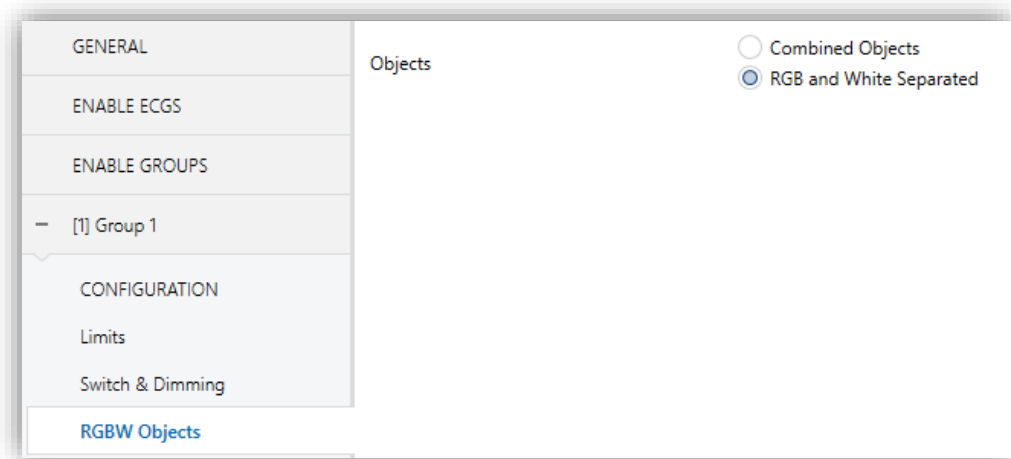

Figure 37. RGBW Objects.

- **Objects** [*Combined Objects* / *RGB and White Separated*]: selecting “RGB and White Objects” objects “[Group n] Channel RGB Absolute Dimming”, “[Group n] Channel W Relative Dimming” and “[Group n] Channel W Absolute Dimming” will be displayed. Selecting “Combined Objects” object “[Group n] Channels RGBW Absolute Dimming” will be displayed.

According to parameterisation of tab “Status Objects” (see section 2.8.4) the following objects will be displayed.

- “[Group n] Channels RGB Dimming Value (Status)”
- “[Group n] Channel W Dimming Value (Status)”
- “[Group n] Channels RGBW Dimming Value (Status)”

2.8.12.3 COLOUR TEMPERATURE

The colour temperature control enables the control of temperature ballasts. Control over this type of ballast can be done by means of a 4-bit object and a 2-byte object, which will be enabled after choosing this option among those available for colour control (see section 2.3).

Colour Temperature Control follows the colours plot displays in Figure 38, where lower values are the warm colours and the higher temperature values are tantamount to cool colours.



Figure 38. Colour Temperature Control

The Figure 38 also displays the Mireck temperature, which is the unit used by DALI Standard.

$$Temperature (Mirek) = \frac{1.000.000}{Temperature (Kelvin)}$$

ETS PARAMETERISATION

After selecting “Colour Temperature” as colour option, on “Enable Groups” (section 2.3) the following objects will be displayed:

- “[Group n] Colour Temperature Relative Dimming”.
- “[Group n] Colour Temperature Absolute Dimming”.

Additionally, a new tab will be displayed with the following parameters:

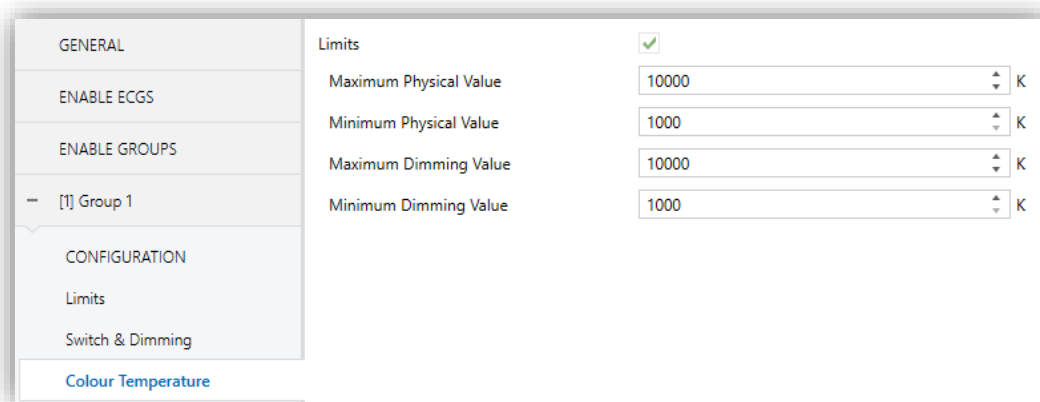

Figure 39. Colour Temperature

- **Limits** [*enabled/disabled*]: sets dimming limits for each group. Enabling this parameter, configuring the followings is possible:
 - **Maximum Physical Value** [1000...10000...20000][K]: Maximum value of the colour temperature of the cold LEDs, indicated on the cold LED datasheet.

- **Minimum Physical Value** [1000...20000][K]: Minimum value of the colour temperature of the warm LEDs, indicated on the cold LED datasheet.
- **Maximum Dimming Value** [1000...10000...20000][K]: Maximum value that can be set per object.
- **Minimum Dimming Value** [1000...20000][K]: Minimum value that can be set per object.

According to parameterisation of tab “Status Objects” (see section 2.8.4) the status object “[Group n] Colour Temperature Dimming Value (Status)” will be displayed:

Note: For proper operation, the limit values of a colour temperature control ballast must follow the following rule:

$$\text{Min. Physical Value} \leq \text{Min. Dimming Value} < \text{Max. Dimming Value} \leq \text{Max. Physical Value}$$

2.8.13 ECG M

Other than the additional functions and options for the group, some specific options will be provided for each of the ballasts that have been enabled and assigned such group. These options are analogous to the basic options available for ballasts with no group assignment. Please refer to section P for more details.

ETS PARAMETERISATION

When new ballasts become enabled (see section 2.2) and assigned to a group, new sub-tabs (one per ballast) will be incorporated under the “Group N” tab, being N the number of the group they belong to.

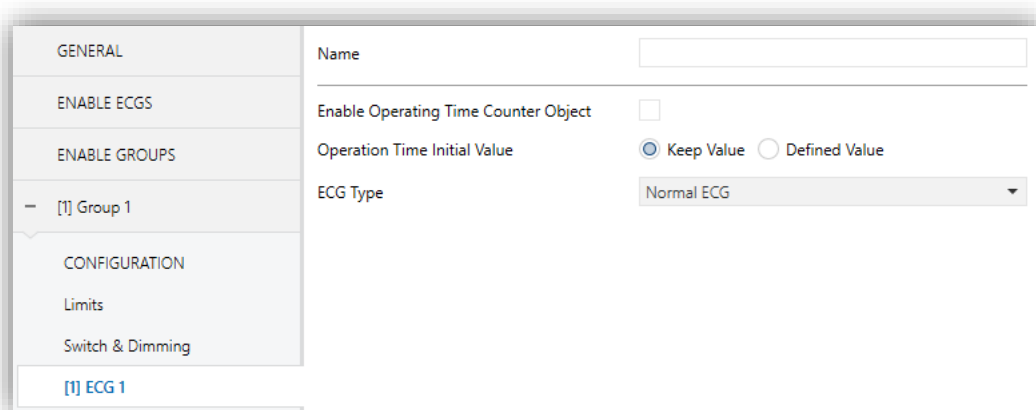

Figure 40. Group N – ECG M

The options they contain are entirely analogous to those describe in section 2.7.1 for ballasts with no group assignment.

3 DISPLAY

3.1 MAIN MENU

DALI-BOX Interface v2 incorporates a **128x64 pixel display** together with **six additional buttons** to browse through the options it shows.

During normal device operation of the device, the screen remains off to save power. Pressing on a button (arrows, OK or ESC) will activate it back and show the main menu. After **a minute** without further interaction, it will turn off again.

This **main menu** (i.e., the upper level) includes a list with the following options:

1. Installation
2. ECG Detection
3. Switch All ECGs
4. Reset All ECGs
5. Manual Control
6. Scene Control
7. Burn-in Control
8. Application Version

It is possible to browse through them by pressing on ▼ and ▲. To enter any of the submenus, please press OK. To return to the previous menu, please press ESC.

Notes:

- if a power supply failure or a short-circuit error takes place, the display will switch back to the upper menu in case any of the submenus has been opened. A “**Bus Error**” message will be shown if trying to open any submenu until the error is over.
- DALI-BOX Interface v2 represent **characters** of the follow **alphabets**: Latin, extended Latin, Cyrillic and some special characters ((€ ¢ £ ° ° ñ).

3.2 INSTALLATION

This submenu allows performing the following actions, which may be useful during the installation of the DALI system or during later maintenance:

- Testing the ECGs present in the DALI bus.
- Identifying or modifying the addresses of the ECGs detected.
- Identifying or modifying the group assignment of each ECG.
- Checking any errors on the ECGs and resetting the presence error.
- Checking the operating hours of the ECGs and resetting the time count.

All the above actions can be performed over any ECGs present in the line, even if they have not been enabled in parameters before (see section 2.2).

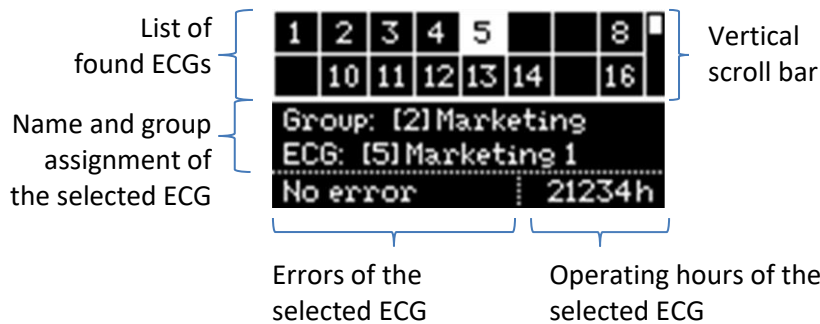

Figure 41. Installation Submenu

Note: after leaving the Installation menu, the previous dimming values are resumed, in case they have been modified.

3.2.1 SELECTION AND ECG TESTING

The cells in the upper table represent the detected ballasts. Empty cells correspond to addresses that have not been assigned to any of the ballasts. To step through the different cells, please make use of the arrow buttons. Note that only two rows are shown simultaneously – to reach the other rows please make use of the up and down arrow buttons.

The currently highlighted box will **blink** every second, and so will do the corresponding ballast thus making it possible to identify which ballast has been assigned each address.

By pressing on **OK**, the selected cell will become surrounded by a dotted line and the ballast will interrupt the on-off sequence. This allows entering into the group assignment section.

Note: ballasts which do not allow regulation may not cause the lamp to blink.

3.2.2 GROUP ASSIGNMENT

After entering the group assignment section, the ◀ and ▶ buttons allow browsing through the available groups. The “**No Group**” option is available at the end of the list. To set the assignment please press on **OK**. A pop-up message (“**Change Group?**”) will ask for confirmation, which consists in pressing on **OK** again.



Figure 42. Group Assignment

Figure 42 shows how the display looks like when ballast with address 5 (initially belonging to group number 2) is re-assigned group number 3.

Important: if a ballast is assigned an individual group (17-64) previously assigned to another ballast, the latter will change to “**No group**”.

To enter the ECG address assignment section, please press ▼. To switch back to the upper table, please press ESC or ▲.

3.2.3 ADDRESS ASSIGNMENT

Analogously as in section 3.2.2, it is possible to modify the address of the selected ballast. After entering this section, ◀ and ▶ will permit browsing through the available addresses (both unused addresses and addresses already in use).

Free addresses and addresses automatically assigned by DALI-BOX Interface v2 (which therefore have not been given a name in ETS; see section 2.2) will simply show as a number in square brackets, with no name.



Figure 43. ECG Address

To confirm the assignment please press on **OK**. It is important to bear in mind that:

- When assigning an address that was free, the current cell in the table will become empty while the cell corresponding to the new address will no longer be empty.
- When assigning an address that was already assigned to another ballast, DALI-BOX Interface v2 will automatically assign the latter a new address. In case the sixty-four addresses are already in use, **the assignment will not be possible**: after pressing on OK, the current address will remain assigned. In such case, in order to perform an address swap, it is advisable to disconnect a ballast whose address has not been configured yet (thus, a ballast whose address has been assigned automatically), perform the intended assignment and re-connect the ballast (which will be automatically assigned by DALI-BOX Interface v2 the only address available).

To enter the ballast errors section, please press ▼.

3.2.4 BALLAST ERRORS

This box will reflect the errors of the selected ballast (see section 2.1.1):

- If no errors are present, the box will show **“No error”**.
- In case of a presence error, an ECG error or a lamp error, the box will respectively show **“Err: Presence”**, **“Err: ECG Failure”** and **“Err: Lamp Failure”**. In case the latter two errors take place simultaneously, it will show **“Err: ECG & Lamp”**.

- Power supply errors and short-circuit errors will be indicated by DALI-BOX Interface v2, respectively, through the messages “**Bus Error: Power Supply**” and “**Bus Error: Shor Circuit**” directly when trying to enter the Installation submenu.

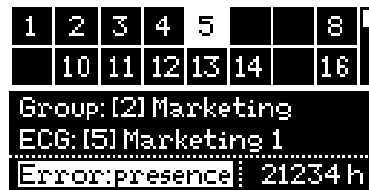

Figure 44. ECG Errors

Ballasts under the ECG presence error can be removed from the upper table in case they are not necessary anymore and therefore have been removed from the DALI bus. To that end, once in the ballast errors section of a ballast in such situation, please press on **OK**. Pressing a second time on **OK** will confirm the “**Delete ECG?**” dialogue, and therefore the ballast will be removed. To cancel the action, please press any other button.



Figure 45. Deleting an ECG

To enter the operating time section, please press ▼.

3.2.5 OPERATING TIME

This box shows the total operation hours of the selected ballast (see section 2.7.1 and section 2.8.13) even if the associated object has not been enabled in parameters. Note that this count is performed by DALI-BOX Interface v2 according to the hours it maintains the ballast dimming level over 0%.



Figure 46. Operating time

Once in this section, to reset this time count to zero (e.g., when replacing the lamp in the ballast) please press **OK**. After the “**Reset Time?**” message shows, please press **OK** again to confirm the action or any other button to cancel.

3.3 ECG DETECTION

This submenu enables or disables the automatic detection functionality for new ballasts, in the same way as through the “**ECG Automatic Detection**” object.

By selecting “ECG Detection” submenu, the status of this functionality will be detected and one of the following messages will be displayed, as appropriate:

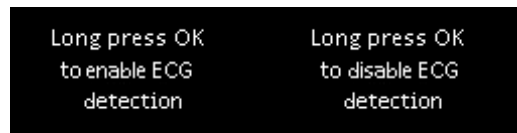

Figure 47 ECG Detection

Thus, a long press on the **OK** button will apply the opposite status to the current one.

3.4 SWITCH ALL ECGS

This submenu allows switching on/off all the ballasts connected to the installation with a long press of the OK button.

If all groups are switched on, ECGs will switch off. In other case, all groups will switch on. ECGs with no group assignment or no assigned address will not be switched.

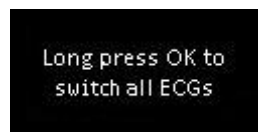

Figure 48 Switch All ECGs

3.5 RESET ALL ECGS

This submenu allows resetting all the ballasts connected to the bus to their defaults, thus removing their address assignments, after which DALI-BOX Interface v2 will proceed with the **automatic ECG detection and address assignment process after one**

minute. This delay allows the integrator to disconnect from the DALI bus any ballasts that may not need to be assigned a new address.

This process **does not alter the group assignments.**

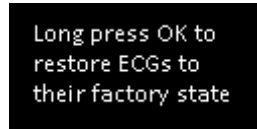

Figure 49. Reset All ECGs Submenu

After a long press on **OK**, the “**Restore ECGs?**” message will show. To confirm, please short-press **OK** and the process will start. Otherwise, please press on any other button.

Note: as *Reset* is an action manage for the user, *ECG Detection* will be enabled the first detection cycle in order to monitor the reset ballasts. After the first loop, *ECG Detection* status will return to the previous.

3.6 MANUAL CONTROL

This submenu allows controlling the dimming level of the different groups manually. The **actions that can be performed** are: switch-on, switch-off, upward dimming and downward dimming.

After entering this submenu, a group selection table will show on the upper section of the display. Empty cells correspond to group numbers (between 1 and 32) not being used. Please make use of ◀, ▶, ▼ and ▲ to browse through all of them.

The lower section of the display will show the number and (if set in parameters) the name of the selected group.



Figure 50. Manual Control

To begin controlling the group, please press **OK**. The lower section will then show the corresponding **instructions**:

● Encendido: ▶

- Apagado: ◀
- Regulación ascendente: ▲
- Regulación descendente: ▼



Figure 51. Manual Control - Instructions

3.7 SCENE CONTROL

This submenu allows manually controlling the scene **execution** and **saving**. Scene saving will only be possible in case it has been enabled in parameters (section 2.4).

After entering this submenu, a table with the **16 available scenes** is shown. Please make use of ◀, ▶, ▼ and ▲ to browse through them. Note that empty cells correspond to scenes that have not been enabled.

The lower section shows the instructions on how to run or save the scene:

- **To run the selected scene**, please short press on **OK**.
- **To save the selected scene**, please long-press on **OK**.

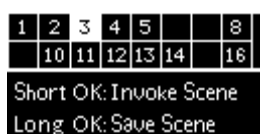

Figure 52. Scene Control

After running or saving a scene, a confirmation text will be shown (respectively, “**Scene N invoked**” or “**Scene N saved**”).

3.8 BURN-IN CONTROL

This submenu allows checking the **burn-in mode status** (see section 2.8.11.2) of each group, as well as **activating** or **deactivating** this mode. This may be a requirement of some lamps prior to testing them.

After entering this submenu, the upper section of the display will show a group selection table analogous to that in the manual control submenu (see section 3.6). On the other side, the lower section will show the number, the name and the burn-in mode status of the selected group, together with the instructions to activate or deactivate this mode (**long press on OK** to activate it or, if already active, **long press on OK** to deactivate it).

1	2	3	4	5		8	
	10	11	12	13	14		16
Group: [2] Marketing							
Burn-in state: On							
Long Press Ok to Turn OFF							

Figure 53. Burn-in Control

Important: *in case the burn-in mode of a particular group has not been enabled in parameters, it will still show up in the group selection table, however the message “**Burn-in state: not available**” will be shown if trying to activate it.*

3.9 APPLICATION VERSION

The Application Version submenu indicates, through the same text line of the main menu, the currently downloaded version of the device application program.

2. Reset All EDGs
3. Manual Control
4. Scene Control
5. Burn-in Control
6. ApplicationVersion:1.4

Figure 54. Application Version

ANNEX I. COMMUNICATION OBJECTS

- “**Functional range**” shows the values that, with independence of any other values permitted by the bus according to the object size, may be of any use or have a particular meaning because of the specifications or restrictions from both the KNX standard or the application programme itself.

Number	Size	I/O	Flags	Data type (DPT)	Functional Range	Name	Function
1, 2, 3	2 Bytes	I	C - W - -	DPT_TimePeriodSec	0 - 65535	Dimming Time x	Time in Seconds
4	1 Byte	I	C - W - -	DPT_SceneControl	0-63; 128-191	Scene Control	0 - 63 (Run Scene 1 - 64); 128 - 191 (Save 1 - 64)
	1 Byte	I	C - W - -	DPT_SceneNumber	0 - 63	Scene Control	0 - 63 (Run Scene 1 - 64)
5	1 Byte	I	C - W - -	DPT_DALI_Efect_1_Byte		Sequence Control	Sequence Number + Start/Stop
6	1 Byte	I	C - W - -	DPT_SceneNumber	0 - 63	Sequence Launcher	Start Sequence Number
7	1 Bit	I	C - W - -	DPT_Trigger	0/1	Stop Sequences	Stop All Sequences
8, 9, 10, 11, 12, 13, 14, 15, 16, 17, 18, 19, 20, 21, 22, 23	1 Bit	O	C R - T -	DPT_Switch	0/1	Standby x (Status)	0 = Standby Off; 1 = Standby On
	1 Bit	O	C R - T -	DPT_Switch	0/1	Standby x (Status)	0 = Standby On; 1 = Standby Off
24	1 Bit	O	C R - T -	DPT_Alarm	0/1	Error: DALI Power Supply	0 = No Error; 1 = DALI Power Supply Failure
25	1 Bit	O	C R - T -	DPT_Alarm	0/1	Error: Short Circuit	0 = No Error; 1 = Short Circuit
26	1 Bit	I/O	C R W T -	DPT_Alarm	0/1	Error: ECG Presence	0 = No Error; 1 = ECG Presence Failure
27	2 Bytes	I	C - W T -	DPT_DALI_Control_Gear_Diagnostics		ECG and Group Diagnostic	ECG and Group Diagnostic
28	1 Byte	O	C R - T -	DPT_DALI_Diagnostic		ECG Diagnostics	ECG Diagnostics
29	1 Bit		C - - T -	DPT_Trigger	0/1	[Heartbeat] Object to Send '1'	Sending of '1' Periodically
30	1 Bit		C - - T -	DPT_Trigger	0/1	[Heartbeat] Device Recovery	Send 0
31	1 Bit		C - - T -	DPT_Trigger	0/1	[Heartbeat] Device Recovery	Send 1
32	1 Bit	I	C - W - -	DPT_Enable	0/1	ECG Automatic Detection	0 = Disable; 1 = Enable
33	1 Bit	I	C - W - -	DPT_Enable	0/1	Collisions Detection	0 = Disable; 1 = Enable
34	1 Bit	I	C - W - -	DPT_Enable	0/1	Manual Control Lock	0 = UnLock; 1 = Lock
	1 Bit	I	C - W - -	DPT_Enable	0/1	Manual Control Lock	0 = Lock; 1 = UnLock
35, 61, 87, 113, 139, 165, 191, 217, 243, 269, 295, 321, 347, 373, 399, 425, 451, 477, 503, 529, 555, 581, 607, 633, 659, 685,	1 Bit	I	C - W - -	DPT_Switch	0/1	[Group x] On/Off	0 = Off; 1 = On

711, 737, 763, 789, 815, 841, 867, 893, 919, 945, 971, 997, 1023, 1049, 1075, 1101, 1127, 1153, 1179, 1205, 1231, 1257, 1283, 1309, 1335, 1361, 1387, 1413, 1439, 1465, 1491, 1517, 1543, 1569, 1595, 1621, 1647, 1673							
36, 62, 88, 114, 140, 166, 192, 218, 244, 270, 296, 322, 348, 374, 400, 426, 452, 478, 504, 530, 556, 582, 608, 634, 660, 686, 712, 738, 764, 790, 816, 842, 868, 894, 920, 946, 972, 998, 1024, 1050, 1076, 1102, 1128, 1154, 1180, 1206, 1232, 1258, 1284, 1310, 1336, 1362, 1388, 1414, 1440, 1466, 1492, 1518, 1544, 1570, 1596, 1622, 1648, 1674	4 Bit	I	C - W - -	DPT_Control_Dimming	0x0 (Stop) 0x1 (Dec. by 100%) ... 0x7 (Dec. by 1%) 0x8 (Stop) 0xD (Inc. by 100%) ... 0xF (Inc. by 1%)	[Group x] Relative Dimming	4-Bit Dimmer Control
37, 63, 89, 115, 141, 167, 193, 219, 245, 271, 297, 323, 349, 375, 401, 427, 453, 479, 505, 531, 557, 583, 609, 635, 661, 687, 713, 739, 765, 791, 817, 843, 869, 895, 921, 947, 973, 999, 1025, 1051, 1077, 1103, 1129, 1155, 1181, 1207, 1233, 1259, 1285, 1311, 1337, 1363, 1389, 1415, 1441, 1467, 1493, 1519, 1545, 1571, 1597, 1623, 1649, 1675	1 Byte	I	C - W - -	DPT_Scaling	0% - 100%	[Group x] Absolute Dimming	1-Byte Dimmer Control
38, 64, 90, 116, 142, 168, 194, 220, 246, 272, 298, 324, 350, 376, 402, 428, 454, 480, 506, 532, 558, 584, 610, 636, 662, 688, 714, 740, 766, 792, 818, 844, 870, 896, 922, 948, 974, 1000, 1026, 1052, 1078, 1104, 1130, 1156, 1182, 1208, 1234, 1260, 1286, 1312, 1338, 1364,	1 Byte	O	C R - T -	DPT_Scaling	0% - 100%	[Group x] Dimming Value (Status)	0 - 100%

1390, 1416, 1442, 1468, 1494, 1520, 1546, 1572, 1598, 1624, 1650, 1676							
39, 65, 91, 117, 143, 169, 195, 221, 247, 273, 299, 325, 351, 377, 403, 429, 455, 481, 507, 533, 559, 585, 611, 637, 663, 689, 715, 741, 767, 793, 819, 845, 871, 897, 923, 949, 975, 1001, 1027, 1053, 1079, 1105, 1131, 1157, 1183, 1209, 1235, 1261, 1287, 1313, 1339, 1365, 1391, 1417, 1443, 1469, 1495, 1521, 1547, 1573, 1599, 1625, 1651, 1677	1 Bit	O	C - R - T - -	DPT_Switch	0/1	[Group x] On/Off (Status)	0 = Off; 1 = On
40, 66, 92, 118, 144, 170, 196, 222, 248, 274, 300, 326, 352, 378, 404, 430, 456, 482, 508, 534, 560, 586, 612, 638, 664, 690, 716, 742, 768, 794, 820, 846, 872, 898, 924, 950, 976, 1002, 1028, 1054, 1080, 1106, 1132, 1158, 1184, 1210, 1236, 1262, 1288, 1314, 1340, 1366, 1392, 1418, 1444, 1470, 1496, 1522, 1548, 1574, 1600, 1626, 1652, 1678	1 Bit	I	C - W - - -	DPT_Switch	0/1	[Group x] Custom On/Off	0 = Off; 1 = On
41, 67, 93, 119, 145, 171, 197, 223, 249, 275, 301, 327, 353, 379, 405, 431, 457, 483, 509, 535, 561, 587, 613, 639, 665, 691, 717, 743, 769, 795, 821, 847, 873, 899, 925, 951, 977, 1003, 1029, 1055, 1081, 1107, 1133, 1159, 1185, 1211, 1237, 1263, 1289, 1315, 1341, 1367, 1393, 1419, 1445, 1471, 1497, 1523, 1549, 1575, 1601, 1627, 1653, 1679	1 Bit	I	C - W - - -	DPT_DayNight	0/1	[Group x] Day/Night Mode	0 = Day Mode; 1 = Night Mode
	1 Bit	I	C - W - - -	DPT_DayNight	0/1	[Group x] Day/Night Mode	0 = Night Mode; 1 = Day Mode
42, 68, 94, 120, 146, 172, 198, 224, 250, 276, 302, 328, 354, 380, 406, 432,	1 Bit	I	C - W - - -	DPT_Switch	0/1	[Group x] Day/Night Mode On/Off	0 = Off; 1 = On

458, 484, 510, 536, 562, 588, 614, 640, 666, 692, 718, 744, 770, 796, 822, 848, 874, 900, 926, 952, 978, 1004, 1030, 1056, 1082, 1108, 1134, 1160, 1186, 1212, 1238, 1264, 1290, 1316, 1342, 1368, 1394, 1420, 1446, 1472, 1498, 1524, 1550, 1576, 1602, 1628, 1654, 1680							
43, 69, 95, 121, 147, 173, 199, 225, 251, 277, 303, 329, 355, 381, 407, 433, 459, 485, 511, 537, 563, 589, 615, 641, 667, 693, 719, 745, 771, 797, 823, 849, 875, 901, 927, 953, 979, 1005, 1031, 1057, 1083, 1109, 1135, 1161, 1187, 1213, 1239, 1265, 1291, 1317, 1343, 1369, 1395, 1421, 1447, 1473, 1499, 1525, 1551, 1577, 1603, 1629, 1655, 1681	1 Bit	I	C - W - -	DPT_Start	0/1	[Group x] Simple Timer	0 = Deactivate; 1 = Activate
44, 70, 96, 122, 148, 174, 200, 226, 252, 278, 304, 330, 356, 382, 408, 434, 460, 486, 512, 538, 564, 590, 616, 642, 668, 694, 720, 746, 772, 798, 824, 850, 876, 902, 928, 954, 980, 1006, 1032, 1058, 1084, 1110, 1136, 1162, 1188, 1214, 1240, 1266, 1292, 1318, 1344, 1370, 1396, 1422, 1448, 1474, 1500, 1526, 1552, 1578, 1604, 1630, 1656, 1682	1 Bit	I	C - W - -	DPT_Start	0/1	[Group x] Flashing	0 = Deactivate; 1 = Activate
45, 71, 97, 123, 149, 175, 201, 227, 253, 279, 305, 331, 357, 383, 409, 435, 461, 487, 513, 539, 565, 591, 617, 643, 669, 695, 721, 747, 773, 799, 825, 851, 877, 903, 929, 955, 981, 1007, 1033, 1059, 1085, 1111, 1137, 1163,	1 Bit	I	C - W - -	DPT_Enable	0/1	[Group x] Lock	0 = Unlock; 1 = Lock
	1 Bit	I	C - W - -	DPT_Enable	0/1	[Group x] Lock	0 = Lock; 1 = Unlock

1189, 1215, 1241, 1267, 1293, 1319, 1345, 1371, 1397, 1423, 1449, 1475, 1501, 1527, 1553, 1579, 1605, 1631, 1657, 1683							
46, 72, 98, 124, 150, 176, 202, 228, 254, 280, 306, 332, 358, 384, 410, 436, 462, 488, 514, 540, 566, 592, 618, 644, 670, 696, 722, 748, 774, 800, 826, 852, 878, 904, 930, 956, 982, 1008, 1034, 1060, 1086, 1112, 1138, 1164, 1190, 1216, 1242, 1268, 1294, 1320, 1346, 1372, 1398, 1424, 1450, 1476, 1502, 1528, 1554, 1580, 1606, 1632, 1658, 1684	1 Bit	I	C - W - -	DPT_Alarm	0/1	[Group x] Alarm	0 = No Alarm; 1 = Alarm
47, 73, 99, 125, 151, 177, 203, 229, 255, 281, 307, 333, 359, 385, 411, 437, 463, 489, 515, 541, 567, 593, 619, 645, 671, 697, 723, 749, 775, 801, 827, 853, 879, 905, 931, 957, 983, 1009, 1035, 1061, 1087, 1113, 1139, 1165, 1191, 1217, 1243, 1269, 1295, 1321, 1347, 1373, 1399, 1425, 1451, 1477, 1503, 1529, 1555, 1581, 1607, 1633, 1659, 1685	1 Bit	I	C - W - -	DPT_Alarm	0/1	[Group x] Alarm	0 = Alarm; 1 = No Alarm
48, 74, 100, 126, 152, 178, 204, 230, 256, 282, 308, 334, 360, 386, 412, 438, 464, 490, 516, 542, 568, 594, 620, 646, 672, 698, 724, 750, 776, 802, 828, 854, 880, 906, 932, 958, 984, 1010, 1036, 1062, 1088, 1114, 1140, 1166, 1192, 1218, 1244, 1270, 1296, 1322, 1348, 1374, 1400, 1426, 1452, 1478, 1504, 1530, 1556, 1582, 1608, 1634, 1660, 1686	1 Bit	I	C - W - -	DPT_Ack	0/1	[Group x] Unfreeze Alarm	Alarm = No Alarm + Unfreeze (1) -> End Alarm
48, 74, 100, 126, 152, 178, 204, 230, 256, 282, 308, 334, 360, 386, 412, 438, 464, 490, 516, 542, 568, 594, 620, 646, 672, 698, 724, 750, 776, 802, 828, 854, 880, 906, 932, 958, 984, 1010, 1036, 1062, 1088, 1114, 1140, 1166, 1192, 1218, 1244, 1270, 1296, 1322, 1348, 1374, 1400, 1426, 1452, 1478, 1504, 1530, 1556, 1582, 1608, 1634, 1660, 1686	1 Bit	I	C - W - -	DPT_Enable	0/1	[Group x] Burn-in Mode	0 = Stop Burn-in ; 1 = Start Burn-in

49, 75, 101, 127, 153, 179, 205, 231, 257, 283, 309, 335, 361, 387, 413, 439, 465, 491, 517, 543, 569, 595, 621, 647, 673, 699, 725, 751, 777, 803, 829, 855, 881, 907, 933, 959, 985, 1011, 1037, 1063, 1089, 1115, 1141, 1167, 1193, 1219, 1245, 1271, 1297, 1323, 1349, 1375, 1401, 1427, 1453, 1479, 1505, 1531, 1557, 1583, 1609, 1635, 1661, 1687	1 Bit	O	CR-T-	DPT_Enable	0/1	[Group x] Burn-in Mode (Status)	0 = Burn-in Inactive; 1 = Burn-in Active
50, 76, 102, 128, 154, 180, 206, 232, 258, 284, 310, 336, 362, 388, 414, 440, 466, 492, 518, 544, 570, 596, 622, 648, 674, 700, 726, 752, 778, 804, 830, 856, 882, 908, 934, 960, 986, 1012, 1038, 1064, 1090, 1116, 1142, 1168, 1194, 1220, 1246, 1272, 1298, 1324, 1350, 1376, 1402, 1428, 1454, 1480, 1506, 1532, 1558, 1584, 1610, 1636, 1662, 1688	4 Bytes	I/O	CRWT-	DPT_LongDeltaTimeSec	-2147483648 - 2147483647	[Group x] Burn-in Mode Time	[0 ... 918000] s (0 = Disabled)
51, 77, 103, 129, 155, 181, 207, 233, 259, 285, 311, 337, 363, 389, 415, 441, 467, 493, 519, 545, 571, 597, 623, 649, 675, 701, 727, 753, 779, 805, 831, 857, 883, 909, 935, 961, 987, 1013, 1039, 1065, 1091, 1117, 1143, 1169, 1195, 1221, 1247, 1273, 1299, 1325, 1351, 1377, 1403, 1429, 1455, 1481, 1507, 1533, 1559, 1585, 1611, 1637, 1663, 1689	3 Bytes	I	C-W--	DPT_Colour_RGB	[0 - 255] * 3	[Group x] Channels RGB Absolute Dimming	3-Byte Channels RGB Dimmer Control
52, 78, 104, 130, 156, 182, 208, 234, 260, 286, 312, 338, 364, 390, 416, 442, 468, 494, 520, 546, 572, 598, 624, 650, 676, 702, 728, 754, 780, 806, 832,	3 Bytes	O	CR-T-	DPT_Colour_RGB	[0 - 255] * 3	[Group x] Channels RGB Dimming Value (Status)	Channels RGB Dimming Status

858, 884, 910, 936, 962, 988, 1014, 1040, 1066, 1092, 1118, 1144, 1170, 1196, 1222, 1248, 1274, 1300, 1326, 1352, 1378, 1404, 1430, 1456, 1482, 1508, 1534, 1560, 1586, 1612, 1638, 1664, 1690							
53, 79, 105, 131, 157, 183, 209, 235, 261, 287, 313, 339, 365, 391, 417, 443, 469, 495, 521, 547, 573, 599, 625, 651, 677, 703, 729, 755, 781, 807, 833, 859, 885, 911, 937, 963, 989, 1015, 1041, 1067, 1093, 1119, 1145, 1171, 1197, 1223, 1249, 1275, 1301, 1327, 1353, 1379, 1405, 1431, 1457, 1483, 1509, 1535, 1561, 1587, 1613, 1639, 1665, 1691	6 Bytes	I	C - W - -	DPT_Colour_RGBW	[0 - 1] * 4 - [0 - 255] * 4	[Group x] Channels RGBW Absolute Dimming	6-Byte Channels RGBW Dimmer Control
54, 80, 106, 132, 158, 184, 210, 236, 262, 288, 314, 340, 366, 392, 418, 444, 470, 496, 522, 548, 574, 600, 626, 652, 678, 704, 730, 756, 782, 808, 834, 860, 886, 912, 938, 964, 990, 1016, 1042, 1068, 1094, 1120, 1146, 1172, 1198, 1224, 1250, 1276, 1302, 1328, 1354, 1380, 1406, 1432, 1458, 1484, 1510, 1536, 1562, 1588, 1614, 1640, 1666, 1692	6 Bytes	O	C R - T -	DPT_Colour_RGBW	[0 - 1] * 4 - [0 - 255] * 4	[Group x] Channels RGBW Dimming Value (Status)	Channels RGBW Dimming Status
55, 81, 107, 133, 159, 185, 211, 237, 263, 289, 315, 341, 367, 393, 419, 445, 471, 497, 523, 549, 575, 601, 627, 653, 679, 705, 731, 757, 783, 809, 835, 861, 887, 913, 939, 965, 991, 1017, 1043, 1069, 1095, 1121, 1147, 1173, 1199, 1225, 1251, 1277, 1303, 1329, 1355, 1381, 1407, 1433, 1459, 1485,	4 Bit	I	C - W - -	DPT_Control_Dimming	0x0 (Stop) 0x1 (Dec. by 100%) ... 0x7 (Dec. by 1%) 0x8 (Stop) 0xD (Inc. by 100%) ... 0xF (Inc. by 1%)	[Group x] Channel W Relative Dimming	4-Bit Channel W Dimmer Control

1511, 1537, 1563, 1589, 1615, 1641, 1667, 1693							
56, 82, 108, 134, 160, 186, 212, 238, 264, 290, 316, 342, 368, 394, 420, 446, 472, 498, 524, 550, 576, 602, 628, 654, 680, 706, 732, 758, 784, 810, 836, 862, 888, 914, 940, 966, 992, 1018, 1044, 1070, 1096, 1122, 1148, 1174, 1200, 1226, 1252, 1278, 1304, 1330, 1356, 1382, 1408, 1434, 1460, 1486, 1512, 1538, 1564, 1590, 1616, 1642, 1668, 1694	1 Byte	I	C - W - -	DPT_Scaling	0% - 100%	[Group x] Channel W Absolute Dimming	1-Byte Channel W Dimmer Control
57, 83, 109, 135, 161, 187, 213, 239, 265, 291, 317, 343, 369, 395, 421, 447, 473, 499, 525, 551, 577, 603, 629, 655, 681, 707, 733, 759, 785, 811, 837, 863, 889, 915, 941, 967, 993, 1019, 1045, 1071, 1097, 1123, 1149, 1175, 1201, 1227, 1253, 1279, 1305, 1331, 1357, 1383, 1409, 1435, 1461, 1487, 1513, 1539, 1565, 1591, 1617, 1643, 1669, 1695	1 Byte	O	C R - T -	DPT_Scaling	0% - 100%	[Group x] Channel W Dimming Value (Status)	0 - 100%
58, 84, 110, 136, 162, 188, 214, 240, 266, 292, 318, 344, 370, 396, 422, 448, 474, 500, 526, 552, 578, 604, 630, 656, 682, 708, 734, 760, 786, 812, 838, 864, 890, 916, 942, 968, 994, 1020, 1046, 1072, 1098, 1124, 1150, 1176, 1202, 1228, 1254, 1280, 1306, 1332, 1358, 1384, 1410, 1436, 1462, 1488, 1514, 1540, 1566, 1592, 1618, 1644, 1670, 1696	4 Bit	I	C - W - -	DPT_Control_Dimming	0x0 (Stop) 0x1 (Dec. by 100%) ... 0x7 (Dec. by 1%) 0x8 (Stop) 0xD (Inc. by 100%) ... 0xF (Inc. by 1%)	[Group x] Colour Temperature Relative Dimming	4-Bit Colour Temperature Dimmer Control
59, 85, 111, 137, 163, 189, 215, 241, 267, 293, 319, 345, 371, 397, 423, 449, 475, 501, 527, 553, 579,	2 Bytes	I	C - W - -	DPT_Absolute_Colour_Temperature	0 - 65535	[Group x] Colour Temperature Absolute Dimming	2-Byte Colour Temperature Dimmer Control

605, 631, 657, 683, 709, 735, 761, 787, 813, 839, 865, 891, 917, 943, 969, 995, 1021, 1047, 1073, 1099, 1125, 1151, 1177, 1203, 1229, 1255, 1281, 1307, 1333, 1359, 1385, 1411, 1437, 1463, 1489, 1515, 1541, 1567, 1593, 1619, 1645, 1671, 1697							
60, 86, 112, 138, 164, 190, 216, 242, 268, 294, 320, 346, 372, 398, 424, 450, 476, 502, 528, 554, 580, 606, 632, 658, 684, 710, 736, 762, 788, 814, 840, 866, 892, 918, 944, 970, 996, 1022, 1048, 1074, 1100, 1126, 1152, 1178, 1204, 1230, 1256, 1282, 1308, 1334, 1360, 1386, 1412, 1438, 1464, 1490, 1516, 1542, 1568, 1594, 1620, 1646, 1672, 1698	2 Bytes	O	CR-T-	DPT_Absolute_Colour_Temperature	0 - 65535	[Group x] Colour Temperature Dimming Value (Status)	Colour Temperature Dimming Status
1699, 1703, 1707, 1711, 1715, 1719, 1723, 1727, 1731, 1735, 1739, 1743, 1747, 1751, 1755, 1759, 1763, 1767, 1771, 1775, 1779, 1783, 1787, 1791, 1795, 1799, 1803, 1807, 1811, 1815, 1819, 1823, 1827, 1831, 1835, 1839, 1843, 1847, 1851, 1855, 1859, 1863, 1867, 1871, 1875, 1879, 1883, 1887, 1891, 1895, 1899, 1903, 1907, 1911, 1915, 1919, 1923, 1927, 1931, 1935, 1939, 1943, 1947, 1951	4 Bytes	I/O	CRWT-	DPT_LongDeltaTimeSec	-2147483648 - 2147483647	[ECG x] Operating Time	Time in Seconds
1700, 1704, 1708, 1712, 1716, 1720, 1724, 1728, 1732, 1736, 1740, 1744, 1748, 1752, 1756, 1760, 1764, 1768, 1772, 1776, 1780, 1784, 1788, 1792, 1796, 1800, 1804, 1808, 1812, 1816, 1820, 1824,	1 Byte	I	C-W--	DPT_Converter_Test_Control		[ECG x] Converter Test Control	Control Test Command

1828, 1832, 1836, 1840, 1844, 1848, 1852, 1856, 1860, 1864, 1868, 1872, 1876, 1880, 1884, 1888, 1892, 1896, 1900, 1904, 1908, 1912, 1916, 1920, 1924, 1928, 1932, 1936, 1940, 1944, 1948, 1952						
1701, 1705, 1709, 1713, 1717, 1721, 1725, 1729, 1733, 1737, 1741, 1745, 1749, 1753, 1757, 1761, 1765, 1769, 1773, 1777, 1781, 1785, 1789, 1793, 1797, 1801, 1805, 1809, 1813, 1817, 1821, 1825, 1829, 1833, 1837, 1841, 1845, 1849, 1853, 1857, 1861, 1865, 1869, 1873, 1877, 1881, 1885, 1889, 1893, 1897, 1901, 1905, 1909, 1913, 1917, 1921, 1925, 1929, 1933, 1937, 1941, 1945, 1949, 1953	2 Bytes	O	CR-T-	DPT_Converter_Status	[ECG x] Converter Status	Status of a Converter
1702, 1706, 1710, 1714, 1718, 1722, 1726, 1730, 1734, 1738, 1742, 1746, 1750, 1754, 1758, 1762, 1766, 1770, 1774, 1778, 1782, 1786, 1790, 1794, 1798, 1802, 1806, 1810, 1814, 1818, 1822, 1826, 1830, 1834, 1838, 1842, 1846, 1850, 1854, 1858, 1862, 1866, 1870, 1874, 1878, 1882, 1886, 1890, 1894, 1898, 1902, 1906, 1910, 1914, 1918, 1922, 1926, 1930, 1934, 1938, 1942, 1946, 1950, 1954	6 Bytes	O	CR-T-	DPT_DALI_converter_test_result	[ECG x] Converter Test Result	Result of a Test

Join and send us your inquiries
about Zennio devices:

<https://support.zennio.com>

Zennio Avance y Tecnología S.L.

C/ Río Jarama, 132. Nave P-8.11
45007 Toledo (Spain).

Tel. +34 925 232 002

www.zennio.com
info@zennio.com