



# MAXinBOX 16 Plus

# MAXinBOX 8 Plus

Multifunction Actuator with 16 / 8 Outputs

ZIO-MB8P  
ZIO-MB16P

Application programme version: [1.2]  
User manual edition: [1.2]\_b

# CONTENTS

---

Contents .....	2
Document updates.....	3
1 Introduction .....	4
1.1 MAXinBOX 16 Plus / MAXinBOX 8 Plus .....	4
1.2 Installation.....	5
1.3 Start-Up and Power Loss.....	6
2 Configuration.....	7
2.1 General.....	7
2.2 Outputs.....	8
2.3 Manual Control .....	9
2.4 Logic Functions.....	13
2.5 Scene Temporisatation.....	14
ANNEX I. Communication Objects.....	16

## DOCUMENT UPDATES

---

Version	Changes	Page(s)
[1.2]_b	Minor text revision.	-
[1.2]_a	<b>Changes in the application programme:</b> <ul style="list-style-type: none"><li>• Optimisation of the start-up process.</li></ul>	-
[1.1]_a	<b>Changes in the application programme:</b> <ul style="list-style-type: none"><li>• Update of the 'Relays' Fan Coil module to version 0.2.</li></ul>	-

# 1 INTRODUCTION

---

## 1.1 MAXinBOX 16 PLUS / MAXinBOX 8 PLUS

---

MAXinBOX 16 Plus and MAXinBOX 8 Plus from Zennio are two versatile KNX actuators featuring a wide variety of functions, being both of them entirely equivalent except for the number of relay outputs they offer (sixteen in MAXinBOX 16 Plus and eight in MAXinBOX 8 Plus):

- **8 or 16 relay outputs**, configurable as:
  - Up to **8** (in MAXinBOX 16 Plus) or **4** (in MAXinBOX 8 Plus) independent **shutter channels** (with or without slats),
  - Up to **16** (in MAXinBOX 16 Plus) or **8** (in MAXinBOX 8 Plus) **individual ON/OFF outputs**,
  - Up to **4** (in MAXinBOX 16 Plus) or **2** (in MAXinBOX 8 Plus) **two-pipe fan coil modules** where both the fan speed control and the valve control are performed through relays,
  - A combination of the above.
- **20 customisable, multi-operation logic functions.**
- **Scene-triggered action control**, with an optional delay in the execution.
- **Manual operation / supervision** of the 16 / 8 relay outputs through the on-board pushbuttons and LEDs.

## 1.2 INSTALLATION

MAXinBOX 16 / 8 Plus connects to the KNX bus through the on-board KNX connector.

Once the device is provided with power from the KNX bus, both the individual address and the associated application programme may be downloaded.

This device does not need any additional external power since it is entirely powered through the KNX bus.

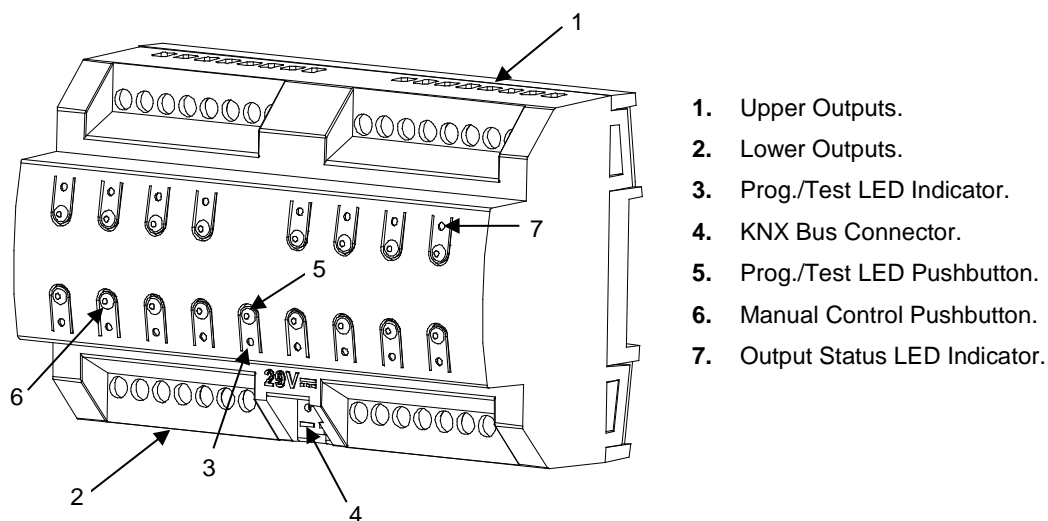

Figure 1. Element Diagram for MAXinBOX 16 Plus

**Note:** the above element diagram is slightly different for MAXinBOX 8 Plus, although entirely analogous.

The main elements of the device are described next.

- **Prog./Test Pushbutton (5):** a short press on this button sets the device into the programming mode, making the associated LED (x) light in red.

**Note:** if this button is held while plugging the device into the KNX bus, the device will enter into **safe mode**. In such case, the LED will blink in red every 0.5 seconds.

- **Outputs (1 and 2):** output ports for the insertion of the stripped cables of the systems being controlled by the actuator (see section 2.2). Please secure the connection by means of the on-board screws.

To get detailed information about the technical features of this device, as well as on the installation and security procedures, please refer to the corresponding **Datasheet**, bundled with the original device packaging and also available at [www.zennio.com](http://www.zennio.com).

### 1.3 START-UP AND POWER LOSS

---

During the start-up of the device, the Prog./Test LED will blink in blue colour for a few seconds before the device is ready. External orders will not be executed during this time, but afterwards.

Depending on the configuration, some specific actions will also be performed during the start-up. For example, the integrator can set whether the output channels should switch to a particular state and whether the device should send certain objects to the bus after the power recovery. Please consult the next sections of this document for further details.

On the other hand, when a bus power failure takes place, MAXinBOX 16 / 8 Plus will interrupt any pending actions, and will save its state so it can be recovered once the power supply is restored.

For safety reasons, all **shutter channels** will be stopped (i.e., the relays will open) if a power loss takes place, while the individual outputs and fan coil contacts will switch to the specific state configured in ETS (if any).

## 2 CONFIGURATION

### 2.1 GENERAL

After importing the corresponding database in ETS and adding the device into the topology of the desired project, the configuration process begins by right-clicking into the device and selecting *Edit parameters*.

#### ETS PARAMETERISATION

The only parameterisable screen available by default is General. From this screen it is possible to activate/deactivate all the required functionality.

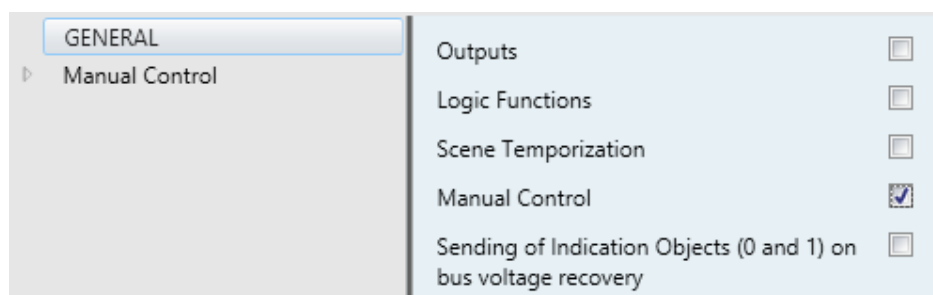

Figure 2. General screen

- Once activated, **Inputs, Outputs, Logic Functions** and **Manual Control** bring additional tabs to the menu on the left. These functions and their parameters will be explained in later sections of this document.
- **Sending of Indication Objects (0 and 1) on Bus Voltage Recovery:** this parameter lets the integrator activate two new communication objects (“**Reset 0**” and “**Reset 1**”), which will be sent to the KNX bus with values “0” and “1” respectively whenever the device begins operation (for example, after a bus power failure). It is possible to parameterise a certain **delay** to this sending (0 to 255 seconds).

## 2.2 OUTPUTS

---

The MAXinBOX 16 / 8 Plus actuator incorporates **16 / 8 relay outputs**, which can be configured as:

- **Individual binary outputs**, which allows an independent control of loads.
- **Shutter channels**, which allow controlling the motion of shutters or blinds.
- **Fan Coil modules**, which allow the control of the fan and the valve of two-pipe fan coil units.

In particular:

- **MAXinBOX 16 Plus**: the sixteen outputs are grouped into two-output channels, which themselves are grouped into two-channel (or four-output) blocks. Therefore, it is possible to configure up to four fan coil modules, or up to eight shutter channels, or up to sixteen individual outputs.
- **MAXinBOX 8 Plus**: the eight outputs are grouped into two-output channels, which themselves are grouped into two-channel (or four-output) blocks. Therefore, it is possible to configure up to two fan coil modules, or up to four shutter channels, or up to eight individual outputs.

For detailed information about the functionality and the configuration of the related parameters, please refer to the following specific manuals, all of them available within the MAXinBOX 16 / 8 Plus product section at the Zennio website ([www.zennio.com](http://www.zennio.com)):

- **Individual outputs.**
- **Shutter channels.**
- **'Relays' Fan Coil.** Note that MAXinBOX 16 / 8 Plus is only compatible with two-pipe fan coils. Therefore, any references to four-pipe fan coils do not apply to this device.



## 2.3 MANUAL CONTROL

---

MAXinBOX 16 / 8 Plus allows manually switching the state of its output relays through the respective pushbuttons on the top of the device. A specific pushbutton is therefore available per output.

Manual operation can be done in two different ways, named as **Test On mode** (for testing purposes during the configuration of the device) and **Test Off mode** (for a normal use, anytime). Whether both, only one, or none of these modes should be accessible needs to be parameterised in ETS. Moreover, it is possible to enable a specific binary object for locking and unlocking the manual control in runtime.

### Notes:

- *The **Test Off mode** will be active (unless it has been disabled by parameter) after a download or a reset with no need of a specific activation – the pushbuttons will respond to user presses from the start.*
- *On the contrary, switching to the **Test On mode** (unless disabled by parameter) needs to be done by long-pressing the Prog/Test button (for at least three seconds), until the LED is no longer red and turns yellow. From that moment, once the button is released, the LED light will remain green to confirm that the device has switched from the Test Off mode to the Test On mode. After that, an additional press will turn the LED yellow and then off, once the button is released. This way, the device leaves the Test On mode. Note that it will also leave this mode if a bus power failure takes place.*



### Test Off Mode

Under the Test Off Mode, the outputs can be controlled through both their communication objects and the actual pushbuttons located on the top of the device.

When one of these buttons is pressed, the output will behave as if an order had been received through the corresponding communication object, depending on whether the output is configured as either an individual output, as a shutter channel or as a fan coil.

- **Individual output:** a simple press (short or long) will make the output switch its on-off state, which will be reported to the KNX bus through the

corresponding status object, if enabled.

- **Shutter Channel:** when the button is pressed, the device will act over the output according to the length of the button press and to the current state.
  - A **long press** makes the shutter start moving (upwards or downwards, depending on the button being pressed). The LED will light in green until the end of the motion. If the button gets pressed being the shutter already at the top or bottom positions, nothing will happen (the LED will not light).
  - A **short press** will make the shutter drive stop (if in motion), as it normally does when a step/stop order is received from the KNX bus. In case of not being the shutter in motion, pressing the button does not cause any action, unless slats/lamellas have been parameterized – in such case, a step movement (up/down, depending on the button pressed) will take place. The status objects will be sent to the bus when corresponding.
  
- **Fan Coil module:** the behaviour will depend on whether a fan-labelled  or a valve-labelled  button is pressed:
  - **Fan:** a short or long press will switch the relays to set the selected speed, unless it matches the current speed – in such case all the relays will be opened (speed 0). The associated LEDs will indicate the state of the fan speed control relays.

**Note:** *the behaviour of the relays will depend on the parameterisation, i.e., on the **number of fan speeds**, on the **delay** between switches and on whether the control type is **accumulation** or **switching**.*
  - **Valve:** a short or long press will switch the current status of the relay and therefore of the valve. The LED will show the state of the relay anytime (on = relay closed; off = relay open).
  
- **Disabled output:** outputs disabled by parameter will not react to button presses under the Test Off mode.

Regarding the lock, timer, alarm and scene functions, the device will behave under the Test Off mode as usual. Button presses during this mode are entirely analogous to the reception of the corresponding orders from the KNX bus.

## Test On Mode

After entering the Test On mode, it will only be possible to control the outputs through the on-board pushbuttons. Orders received through communication objects will be ignored, with independence of the channel or the output they are addressed to.

Depending on whether the output has been parameterized as an individual output or as part of a shutter channel, the reactions to the button presses will differ.

- **Individual output:** short or long pressing the button will commute the on-off state of the relay.
- **Shutter channel:** pressing the button will make the shutter drive move upward or downward (depending on the button) until the button is released again, thus ignoring the position of the shutter and the parameterized times.

**Note:** *after leaving the Test On mode, the status objects will recover the values they had prior to entering Test On. As the device is never aware of the actual position of the shutter (as the shutter drive does not provide any feedback), these values may not show the real position. This can be solved by performing a complete move-up or move-down order, or by calibrating the shutter position in the Test On mode until it matches the status objects.*

- **Fan Coil module:** the behaviour is similar to that of the Test Off mode, although in this case the three fan speeds are supposed available.
- **Disabled output:** short and long presses will switch the state of the corresponding relay. In case this consists in closing the relay, then the remaining relays of its block will open, for safety reasons.

The lock, timer, alarm and scene functions, as well as any other orders received from the bus, will not affect the outputs while the device is under the Test On mode. Status objects will not be sent to the bus, either.

**Important:** *the device is delivered from factory with all the outputs disabled, and with both manual modes (Test Off and Test On) enabled.*

## ETS PARAMETERISATION

The **Manual Control** is configured from the Configuration tab itself under Manual Control.

The only two parameters are:

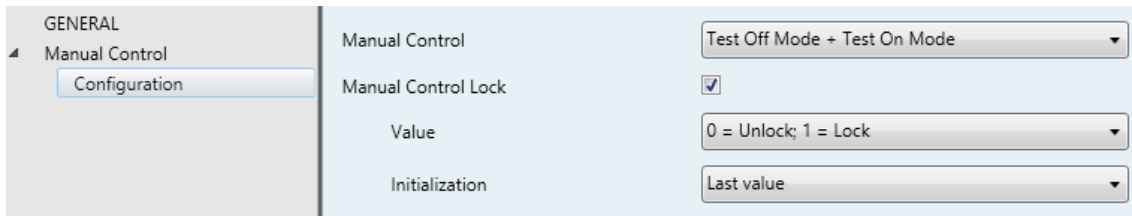

Figure 3. Manual Control

- **Manual Control:** options are “Disabled”, “Only Test Off Mode”, “Only Test On Mode” and “Test Off Mode + Test On Mode” (default). Depending on the selection, the device will permit using the manual control under the Test Off, the Test On, or both modes. Note that, as stated before, using the Test Off mode does not require any special action, while switching to the Test On mode does require long-pressing the Prog/Test button.
- **Manual Control Lock:** unless the above parameter has been “Disabled”, the Lock Manual Control parameter provides an optional procedure for locking the manual control in runtime. When this checkbox is enabled, object “**Manual Control Lock**” turns visible, as well as two more parameters:
  - **Value:** defines whether the manual control lock/unlock should take place respectively upon the reception (through the aforementioned object) of values “0” and “1”, or the opposite.
  - **Initialization:** sets how the lock state of the manual control should remain after the device start-up (after an ETS download or a bus power failure): “Unlocked”, “Locked” or “Last Value” (default; on the very first start-up, this will be Unlocked).

## 2.4 LOGIC FUNCTIONS

---

This module makes it possible to perform numeric and binary operations to incoming values received from the KNX bus, and to send the results through other communication objects specifically enabled for this purpose.

MAXinBOX 16 / 8 Plus can implement **up to 20 different and independent functions**, each of them entirely customisable and consisting in **up to 4 consecutive operations each one**.

The execution of each function can depend on a configurable **condition**, which will be evaluated every time the function is **triggered** through specific, parameterisable communication objects. The result after executing the operations of the function can also be evaluated according to certain **conditions** and afterwards sent (or not) to the KNX bus, which can be done every time the function is executed, periodically or only when the result differs from the last one.

Please refer to the “**Logic Functions**” user manual, available within the MAXinBOX 16 / 8 Plus product section at the Zennio homepage, [www.zennio.com](http://www.zennio.com), for detailed information about the functionality and the configuration of the related parameters.

## 2.5 SCENE TEMPORISATION

The scene temporisation allows imposing **delays over the scenes of the outputs**. These delays are defined in parameters, and can be applied to the execution of one or more scenes that may have been configured.

Please bear in mind that, as multiple delayed scenes can be configured for each individual output / shutter channel / fan coil module, in case of receiving an order to execute one of them when a previous temporisation is still pending for that output / channel / module, such temporisation will be interrupted and only the delay and the action of the new scene will be executed.

### ETS PARAMETERISATION

Prior to setting the **scene temporisation**, it is necessary to have one or more scenes configured in some of the outputs. When entering the Configuration window under Scene Temporization, all configured scenes will be listed, together with a few checkboxes to select which of them need to be temporised, as shown in Figure 4.

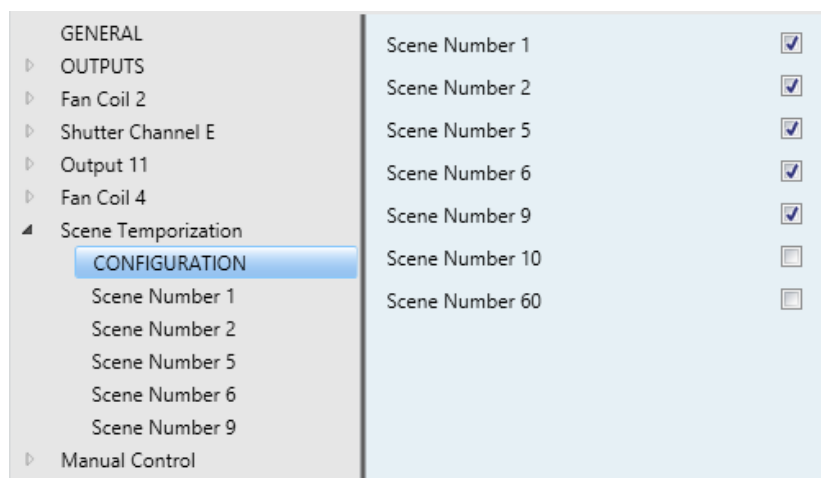

Figure 4. Scene Temporization

Enabling a certain scene number n brings a new tab with such name to the menu on the left, from which it is possible to configure the temporisation of that scene for each of the outputs where it has been configured.

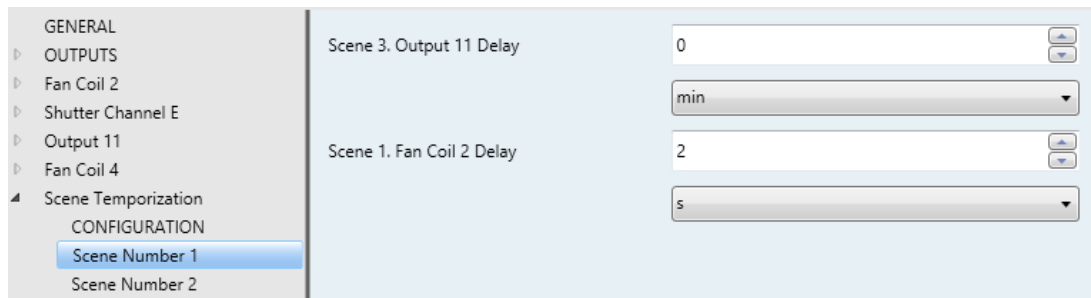

Figure 5. Configuration of Scene Temporization

Therefore, parameter “**Scene m. Z Delay**” defines the delay that will be applied to the action defined in Z for the execution of scene m (where Z may be a specific individual output, shutter channel or fan coil module). The range of this delay is 0 to 3600 seconds, 0 to 1440 minutes or 0 to 24 hours.

## ANNEX I. COMMUNICATION OBJECTS

- “Functional range” shows the values that, with independence of any other values permitted by the bus according to the object size, may be of any use or have a particular meaning because of the specifications or restrictions from both the KNX standard or the application programme itself.

Number	Size	I/O	Flags	Data type (DPT)	Functional Range	Name	Function
1	1 Bit		C T - - -	DPT_Trigger	0/1	Reset 0	Voltage Recovery -> Sending of 0
2	1 Bit		C T - - -	DPT_Trigger	0/1	Reset 1	Voltage Recovery -> Sending of 1
3	1 Bit	I	C - - W -	DPT_Switch	0/1	Lock Manual Control	0 = Lock; 1 = Unlock
	1 Bit	I	C - - W -	DPT_Switch	0/1	Lock Manual Control	0 = Unlock; 1 = Lock
4	1 Byte	I	C - - W -	DPT_SceneControl	0-63; 128-191	[Shutter] Scenes	0 - 63 (Execute 1 - 64); 128 - 191 (Save 1 - 64)
5, 22, 39, 56, 73, 90, 107, 124	1 Bit	I	C - - W -	DPT_UpDown	0/1	[Cx] Move	0=Raise; 1=Lower
6, 23, 40, 57, 74, 91, 108, 125	1 Bit	I	C - - W -	DPT_Step	0/1	[Cx] Stop/Step	0=Stop/StepUp; 1=Stop/StepDown
	1 Bit	I	C - - W -	DPT_Trigger	0/1	[Cx] Stop	0=Stop; 1=Stop
7, 24, 41, 58, 75, 92, 109, 126	1 Bit	I	C - - W -	DPT_Enable	0/1	[Cx] Lock	0=Unlock; 1=Lock
8, 25, 42, 59, 76, 93, 110, 127	1 Bit	O	C T R - -	DPT_Switch	0/1	[Cx] Rising Relay (Status)	0=Opened; 1=Closed
9, 26, 43, 60, 77, 94, 111, 128	1 Bit	O	C T R - -	DPT_Switch	0/1	[Cx] Lowering Relay (Status)	0=Opened; 1=Closed
10, 27, 44, 61, 78, 95, 112, 129	1 Byte	O	C T R - -	DPT_Scaling	0% - 100%	[Cx] Shutter Position (Status)	0%=Top; 100%=Bottom
11, 28, 45, 62, 79, 96, 113, 130	1 Byte	O	C T R - -	DPT_Scaling	0% - 100%	[Cx] Slats Position (Status)	0%=Open; 100%=Closed
12, 29, 46, 63, 80, 97, 114, 131	1 Byte	I	C - - W -	DPT_Scaling	0% - 100%	[Cx] Shutter Positioning	0%=Top; 100%=Bottom
13, 30, 47, 64, 81, 98, 115, 132	1 Byte	I	C - - W -	DPT_Scaling	0% - 100%	[Cx] Slats Positioning	0%=Open; 100%=Closed
14, 31, 48, 65,	1 Bit	I	C - - W -	DPT_Alarm	0/1	[Cx] Alarm	0=No Alarm; 1=Alarm



82, 99, 116, 133	1 Bit	I	C - - W -	DPT_Alarm	0/1	[Cx] Alarm	0=Alarm; 1=No Alarm
15, 32, 49, 66, 83, 100, 117, 134	1 Bit	I	C - - W -	DPT_Alarm	0/1	[Cx] Alarm 2	0=No Alarm; 1=Alarm
	1 Bit	I	C - - W -	DPT_Alarm	0/1	[Cx] Alarm 2	0=Alarm; 1=No Alarm
16, 33, 50, 67, 84, 101, 118, 135	1 Bit	I	C - - W -	DPT_Trigger	0/1	[Cx] Unfreeze Alarm	Alarm=0 + Unfreeze=1 => End Alarm
17, 34, 51, 68, 85, 102, 119, 136	1 Bit	I	C - - W -	DPT_UpDown	0/1	[Cx] Move (Reversed)	0=Lower Shutter; 1=Raise Shutter
18, 35, 52, 69, 86, 103, 120, 137	1 Bit	I	C - - W -	DPT_Trigger	0/1	[Cx] Direct Positioning	0=No Action; 1=Go to Position
19, 36, 53, 70, 87, 104, 121, 138	1 Bit	I	C - - W -	DPT_Trigger	0/1	[Cx] Direct Positioning 2	0=No Action; 1=Go to Position
20, 37, 54, 71, 88, 105, 122, 139	1 Bit	I	C - - W -	DPT_Trigger	0/1	[Cx] Direct Positioning (Save)	0=No Action; 1=Save Current Position
21, 38, 55, 72, 89, 106, 123, 140	1 Bit	I	C - - W -	DPT_Trigger	0/1	[Cx] Direct Positioning 2 (Save)	0=No Action; 1=Save Current Position
141	1 Byte	I	C - - W -	DPT_SceneControl	0-63; 128-191	[Outputs] Scenes	0 – 63 (Execute 1 – 64); 128 – 191 (Save 1 – 64)
142, 150, 158, 166, 174, 182, 190, 198, 206, 214, 222, 230, 238, 246, 254, 262	1 Bit	I	C - - W -	DPT_BinaryValue	0/1	[Oy] On/Off	N.O. (0=Open Relay; 1=Close Relay)
	1 Bit	I	C - - W -	DPT_BinaryValue	0/1	[Oy] On/Off	N.C. (0=Close Relay; 1= Open Relay)
143, 151, 159, 167, 175, 183, 191, 199, 207, 215, 223, 231, 239, 247, 255, 263	1 Bit	O	C T R - -	DPT_BinaryValue	0/1	[Oy] On/Off (Status)	0=Output Off; 1=Output On
144, 152, 160, 168, 176, 184, 192, 200, 208, 216, 224, 232, 240, 248, 256, 264	1 Bit	I	C - - W -	DPT_Enable	0/1	[Oy] Lock	0=Unlock; 1=Lock

145, 153, 161, 169, 177, 185, 193, 201, 209, 217, 225, 233, 241, 249, 257, 265	1 Bit	I	C - - W -	DPT_Start	0/1	[Oy] Timer	0=Switch Off; 1=Switch On
146, 154, 162, 170, 178, 186, 194, 202, 210, 218, 226, 234, 242, 250, 258, 266	1 Bit	I	C - - W -	DPT_Start	0/1	[Oy] Flashing	0=Stop; 1=Start
147, 155, 163, 171, 179, 187, 195, 203, 211, 219, 227, 235, 243, 251, 259, 267	1 Bit	I	C - - W -	DPT_Alarm	0/1	[Oy] Alarm	0=Normal; 1=Alarm
	1 Bit	I	C - - W -	DPT_Alarm	0/1	[Oy] Alarm	0=Alarm; 1=Normal
148, 156, 164, 172, 180, 188, 196, 204, 212, 220, 228, 236, 244, 252, 260, 268	1 Bit	I	C - - W -	DPT_Trigger	0/1	[Oy] Unfreeze Alarm	Alarm=0 + Unfreeze=1 => End Alarm
149, 157, 165, 173, 181, 189, 197, 205, 213, 221, 229, 237, 245, 253, 261, 269	1 Bit	O	C T R - -	DPT_Trigger	0/1	[Oy] Warning Time (Status)	0=Normal; 1=Warning
270 - 301	1 Bit	I	C - - W -	DPT_Bool	0/1	[LF] (1 bit) Data Entry x	Binary Data Entry (0/1)
302 - 317	1 Byte	I	C - - W -	DPT_Value_1_Ucount	0 - 255	[LF] (1 byte) Data Entry x	1 byte Data Entry (0-255)
318 - 333	2 Bytes	I	C - - W -	DPST-7-1 DPST-8-1 DPST-9-1		[LF] (2 bytes) Data Entry x	2 bytes Data Entry
334 - 341	4 Bytes	I	C - - W -	DPT_Value_4_Count	-2147483648 - 2147483647	[LF] (4 bytes) DataEntry x	4 bytes Data Entry
342 - 361	1 Bit	O	C T R - -	DPT_Bool	0/1	[LF] Function x - Result	(1 bit) Boolean
	1 Byte	O	C T R - -	DPT_Value_1_Ucount	0 - 255	[LF] Function x - Result	(1 byte) Unsigned
	2 Bytes	O	C T R - -	DPT_Value_2_Ucount	0 - 65535	[LF] Function x - Result	(2 bytes) Unsigned

	4 Bytes	O	<b>CTR--</b>	DPT_Value_4_Count	-2147483648 - 2147483647	[LF] Function x - Result	(4 bytes) Signed
	1 Byte	O	<b>CTR--</b>	DPT_Scaling	0% - 100%	[LF] Function x - Result	(1 byte) Percentage
	2 Bytes	O	<b>CTR--</b>	DPT_Value_2_Count	-32768 - 32767	[LF] Function x - Result	(2 bytes) Signed
	2 Bytes	O	<b>CTR--</b>	DPT_Value_Temp	-273.00 - 670760.00	[LF] Function x - Result	(2 bytes) Float
362	1 Byte	I	<b>C--WU</b>	DPT_SceneControl	0-63; 128-191	[FC] Scenes	0 - 63 (Execute 1 - 64)
363, 394, 425, 456	1 Bit	I	<b>C--WU</b>	DPT_Switch	0/1	[FCz] On/Off	0 = Off; 1 = On
364, 395, 426, 457	1 Bit	O	<b>CTR--</b>	DPT_Switch	0/1	[FCz] On/Off (Status)	0 = Off; 1 = On
365, 396, 427, 458	1 Bit	I	<b>C--WU</b>	DPT_Heat_Cool	0/1	[FCz] Mode	0 = Cool; 1 = Heat
366, 397, 428, 459	1 Bit	O	<b>CTR--</b>	DPT_Heat_Cool	0/1	[FCz] Mode (Status)	0 = Cool; 1 = Heat
367, 398, 429, 460	1 Bit	I	<b>C--WU</b>	DPT_Switch	0/1	[FCz] Fan: Manual/Automatic	0 = Automatic; 1 = Manual
	1 Bit	I	<b>C--WU</b>	DPT_Switch	0/1	[FCz] Fan: Manual/Automatic	0 = Manual; 1 = Automatic
368, 399, 430, 461	1 Bit	O	<b>CTR--</b>	DPT_Switch	0/1	[FCz] Fan: Manual/Automatic (Status)	0 = Automatic; 1 = Manual
	1 Bit	O	<b>CTR--</b>	DPT_Switch	0/1	[FCz] Fan: Manual/Automatic (Status)	0 = Manual; 1 = Automatic
369, 400, 431, 462	1 Bit	I	<b>C--WU</b>	DPT_Step	0/1	[FCz] Manual Fan: Step Control	0 = Down; 1 = Up
370, 401, 432, 463	1 Bit	I	<b>C--WU</b>	DPT_Switch	0/1	[FCz] Manual Fan: Speed 0	0 = Off; 1 = On
371, 402, 433, 464	1 Bit	I	<b>C--WU</b>	DPT_Switch	0/1	[FCz] Manual Fan: Speed 1	0 = Off; 1 = On
372, 403, 434, 465	1 Bit	I	<b>C--WU</b>	DPT_Switch	0/1	[FCz] Manual Fan: Speed 2	0 = Off; 1 = On
373, 404, 435, 466	1 Bit	I	<b>C--WU</b>	DPT_Switch	0/1	[FCz] Manual Fan: Speed 3	0 = Off; 1 = On
374, 405, 436, 467	1 Bit	O	<b>CTR--</b>	DPT_Switch	0/1	[FCz] Fan: Speed 0 (Status)	0 = Off; 1 = On
375, 406, 437, 468	1 Bit	O	<b>CTR--</b>	DPT_Switch	0/1	[FCz] Fan: Speed 1 (Status)	0 = Off; 1 = On
376, 407, 438, 469	1 Bit	O	<b>CTR--</b>	DPT_Switch	0/1	[FCz] Fan: Speed 2 (Status)	0 = Off; 1 = On
377, 408, 439, 470	1 Bit	O	<b>CTR--</b>	DPT_Switch	0/1	[FCz] Fan: Speed 3 (Status)	0 = Off; 1 = On

378, 409, 440, 471	1 Byte	I	C - - W U	DPT_Value_1_Ucount	0 - 255	[FCz] Manual Fan: Enumeration Control	0 = S0; 1 = S1; 2 = S2; 3 = S3
	1 Byte	I	C - - W U	DPT_Value_1_Ucount	0 - 255	[FCz] Manual Fan: Enumeration Control	0 = S0; 1 = S1; 2 = S2
	1 Byte	I	C - - W U	DPT_Value_1_Ucount	0 - 255	[FCz] Manual Fan: Enumeration Control	0 = S0; 1 = S1
379, 410, 441, 472	1 Byte	O	C T R - -	DPT_Value_1_Ucount	0 - 255	[FCz] Fan: Speed Enumeration (Status)	S0 = 0; S1 = 1; S2 = 2; S3 = 3
	1 Byte	O	C T R - -	DPT_Value_1_Ucount	0 - 255	[FCz] Fan: Speed Enumeration (Status)	S0 = 0; S1 = 1; S2 = 2
	1 Byte	O	C T R - -	DPT_Value_1_Ucount	0 - 255	[FCz] Fan: Speed Enumeration (Status)	S0 = 0; S1 = 1
380, 411, 442, 473	1 Byte	I	C - - W U	DPT_Scaling	0% - 100%	[FCz] Manual Fan: Percentage Control	0% = S0; 1-33% = S1; 34-66% = S2; 67-100% = S3
	1 Byte	I	C - - W U	DPT_Scaling	0% - 100%	[FCz] Manual Fan: Percentage Control	0% = S0; 1-50% = S1; 51-100% = S2
	1 Byte	I	C - - W U	DPT_Scaling	0% - 100%	[FCz] Manual Fan: Percentage Control	0% = S0; 1-100% = S1
381, 412, 443, 474	1 Byte	O	C T R - -	DPT_Scaling	0% - 100%	[FCz] Fan: Speed Percentage (Status)	S0 = 0%; S1 = 33,3%; S2 = 66,6%; S3 = 100%
	1 Byte	O	C T R - -	DPT_Scaling	0% - 100%	[FCz] Fan: Speed Percentage (Status)	S0 = 0%; S1 = 50,2%; S2 = 100%
	1 Byte	O	C T R - -	DPT_Scaling	0% - 100%	[FCz] Fan: Speed Percentage (Status)	S0 = 0%; S1 = 100%
382, 413, 444, 475	1 Byte	I	C - - W U	DPT_Scaling	0% - 100%	[FCz] Cooling Fan: Continuous Control	0 - 100 %
	1 Byte	I	C - - W U	DPT_Scaling	0% - 100%	[FCz] Cooling Valve: PI Control (Continuous)	0 - 100 %
383, 414, 445, 476	1 Byte	I	C - - W U	DPT_Scaling	0% - 100%	[FCz] Heating Fan: Continuous Control	0 - 100 %
	1 Byte	I	C - - W U	DPT_Scaling	0% - 100%	[FCz] Heating Valve: PI Control (Continuous)	0 - 100 %
384, 415, 446, 477	1 Bit	I	C - - W U	DPT_OpenClose	0/1	[FCz] Cooling Valve: Control Variable (1 bit)	0 = Open Valve; 1 = Close Valve
	1 Bit	I	C - - W U	DPT_Switch	0/1	[FCz] Cooling Valve: Control Variable (1 bit)	0 = Close Valve; 1 = Open Valve
385, 416, 447, 478	1 Bit	I	C - - W U	DPT_OpenClose	0/1	[FCz] Heating Valve: Control Variable (1 bit)	0 = Open Valve; 1 = Close Valve
	1 Bit	I	C - - W U	DPT_Switch	0/1	[FCz] Heating Valve: Control Variable (1 bit)	0 = Close Valve; 1 = Open Valve
386, 417, 448, 479	1 Bit	O	C T R - -	DPT_OpenClose	0/1	[FCz] Valve (Status)	0 = Opened; 1 = Closed
	1 Bit	O	C T R - -	DPT_Switch	0/1	[FCz] Valve (Status)	0 = Closed; 1 = Opened
388, 419, 450, 481	1 Bit	O	C T R - -	DPT_Switch	0/1	[FCz] Valve: Anti-Seize Protection (Status)	0 = Not Active; 1 = Active
390, 421, 452, 483	1 Bit	O	C T R - -	DPT_Bool	0/1	[FCz] Control Value - Error	0 = No Error; 1 = Error

391, 422, 453, 484	2 Bytes	I	C - - W U	DPT_Value_Temp	-273.00 - 670760.00	[FCz] Ambient Temperature	Ambient Temperature
392, 423, 454, 485	2 Bytes	I	C - - W U	DPT_Value_Temp	-273.00 - 670760.00	[FCz] Setpoint Temperature	Setpoint Temperature
393, 424, 455, 486	2 Bytes	I/O	C T R W U	DPT_TimePeriodMin	1 - 1440	[FCz] Duration of Manual Control	0: Endless; 1 - 1440 min
	2 Bytes	I/O	C T R W U	DPT_TimePeriodHrs	1 - 1440	[FCz] Duration of Manual Control	0: Endless; 1 - 24 h

Join and send us your inquiries  
about Zennio devices:

<http://support.zennio.com>

**Zennio Avance y Tecnología S.L.**  
C/ Río Jarama, 132. Nave P-8.11  
45007 Toledo (Spain).

*Tel. +34 925 232 002*

*www.zennio.com*  
*info@zennio.com*



RoHS